

USER GUIDE

THE LYCAN POWERBOX

THE ELEMENT SERIES



IMPORTANT SAFETY INSTRUCTIONS

IMPORTANT SYMBOLS

WARNING	Indicates potentially dangerous conditions that could result in personal injury
CAUTION	Indicates conditions or practices that could result in damage to the unit or other equipment
NOTE	Indicates procedure or function that is important for proper and safe operation of the unit or other equipment

- Charge your Lycan up completely before use
- Before using the unit, read all of the instructions and information in the user guide.
- Do NOT submerge the unit under water. The unit is not waterproof.
- Do NOT leave the unit outside when raining.
- Do NOT overload the AC or DC outputs. Follow the power and current ratings mentioned in this manual.
- Only use wires and accessories provided by the manufacturer.
- Store the unit in a dry place free from moisture, heat, and water.
- Unplug the unit if it will not be in use for an extended period of time. Make sure to charge the unit once every two months to preserve the battery life.
- Do NOT store or place the unit near fire or places that can achieve higher temperatures. Doing so may cause damage to the internals and/or battery explosion.
- Keep the unit away from small children.
- Do NOT dismantle or modify the system. Doing so might cause irreversible damage and void warranty.
- It's recommended to timely charge the product upon receipt due that there may be self-consumption of battery during transportation and storage.

TABLE OF CONTENTS

GENERAL	03
GEAR OVERVIEW	04
MAIN OVERVIEW	04
DETAILS	05
ACCESSORIES	06
OPERATIONS	08
LCD INFORMATION	08
CHARGING YOUR LYCAN POWERBOX	09
USING YOUR LYCAN POWERBOX	10
USING LED LIGHT	11
USING INTERNAL AND EXTERNAL BATTERY BACK	12
TECHNICAL SPECIFICATIONS	13
MAINTENANCE	14
DAILY MAINTENANCE	14
COMPONENTS REPLACEMENT	14
REGULAR MAINTENANCE	16
TROUBLESHOOTING	16
FAQ	18

GENERAL

Thanks for choosing Renogy's Lycan Powerbox as your new companion. The Lycan features multiple AC and DC output ports while also supporting multiple charging methods such as wall charging, vehicle charging, and solar panel charging. Built with numerous applications in mind, the lycan is your new favorite companion for power outages, camping trips, outdoor events, or even as an eco-friendly alternative to lighten your home's electricity bill. After a few hours of charging from a solar panel, wall outlet, or 12V car charging socket, the Lycan Powerbox can be used to power a number of appliances and devices without the noise and pollution of traditional gas generators. Compact and rugged, it's the perfect little powerhouse to keep you going for up to 1075 watt-hours. And as the first portable solar storage with interchangeable lithium iron phosphate batteries, it's easy to keep the power flowing for hours on end.



GEAR OVERVIEW

GEAR OVERVIEW

1 / OVERVIEW

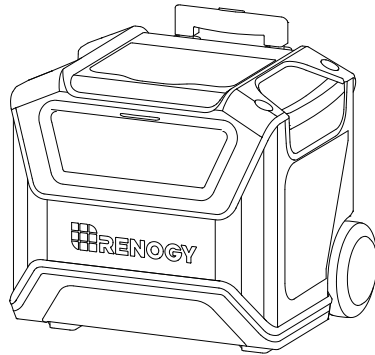

2 / FRONT

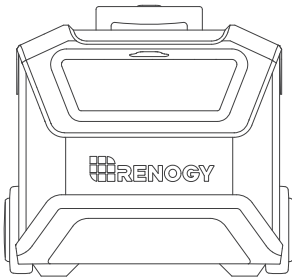

3 / BACK

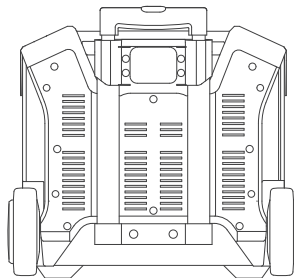

4 / SIDE

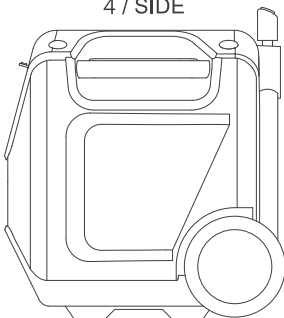

5 / SIDE

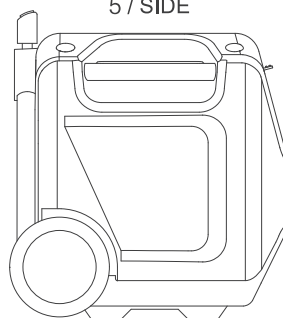

6 / Top

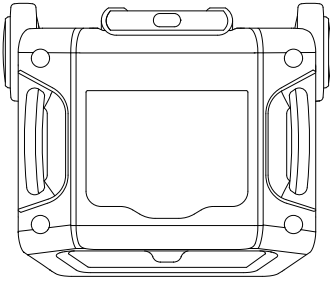

7 / Bottom

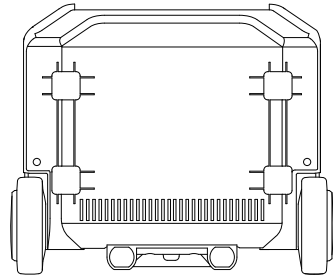

DETAILS

1 / Front Main Panel

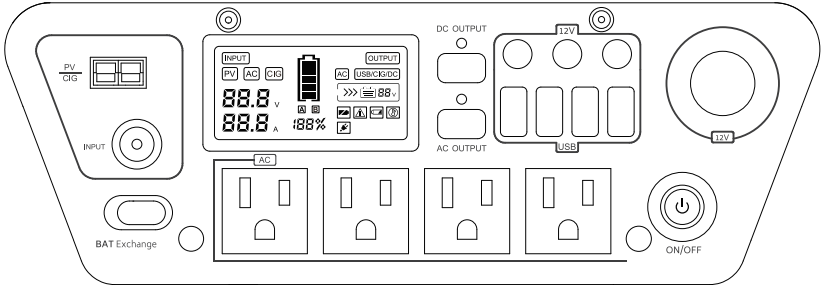

2 / Back Interface

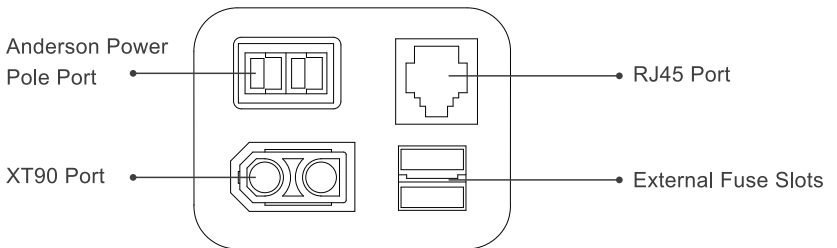

3 / U-Bar Handle

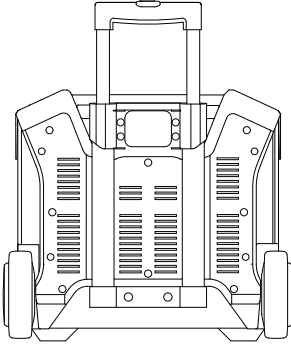

4 / LED Floodlight

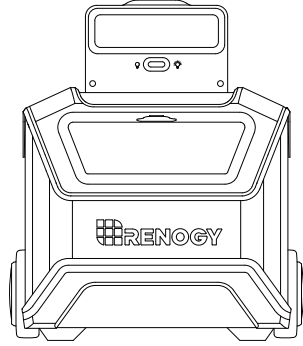

ACCESSORIES

1 / 1 x Lycan Powerbox

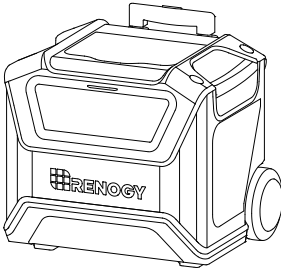

2 / 1 x AC Power Adaptor Cord

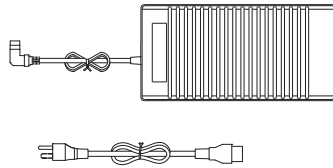

3 / 1 x MC4 to Anderson Power Pole

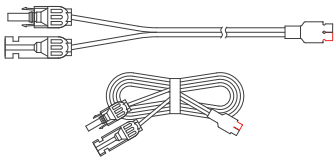

4 / 1 x CIG to Anderson Power Pole



- 5 / 1 x 6.0mm Hex Key, used to unscrew the M8 screws on the upper case.
- 1 x 3.0mm Hex Key, used to unscrew the M4 screws on the trolley.



The following accessories are not included and require separate purchase.

- 6 / 1 x Anderson Power Pole to Alligator Clips

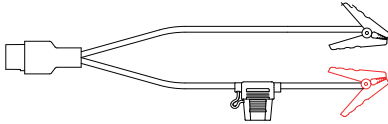

- 7 / 1 x 5.5mm DC to Light Bulb Socket

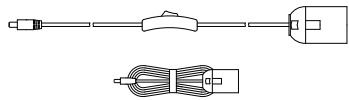

- 8 / 1 x RJ45 cable



- 9 / 1 x XT90 to XT90 cable



Check to make sure you've received all of the accessories mentioned below. Contact the manufacturer if there are any missing or damaged accessories.

Accessory	Qty
Lycan Powerbox	1PC
AC Power Adaptor Cord	1PC
MC4 to Anderson Power Pole	1PC
CIG to Anderson Power Pole	1PC
Hex Key for Upper Case	1PC
Hex Key for trolley	1PC

OPERATIONS

LCD INFORMATION

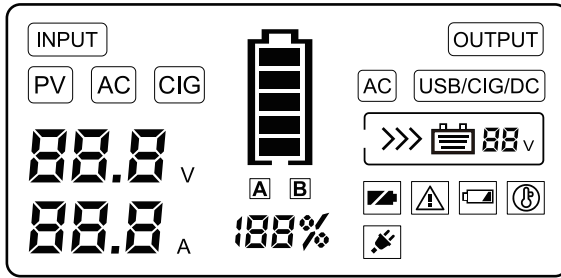

INPUT	Input Display	Turns on when PV, AC, or CIG inputs are being used to charge the Lycan
PV	Solar Charging	Indicates solar charging
AC	Electric Supply Charging	Indicates charging by AC adapter
CIG	Car Charging	Indicates charging with 12V vehicle power
88.8 _V	Charging Voltage	If input display is PV or CIG, it shows the respective connector charging voltage. If it shows AC, then it is the Lithium-Iron Battery Pack charging voltage
88.8 _A	Charging Current	If input display is PV or CIG, it shows the respective connector charging current. If it shows AC, then it is the Lithium-Iron Battery Pack charging current
A B	Indicator of Internal/ External Battery Pack	Distinguishes the internal and external battery packs: 'A' means internal lithium battery pack, and 'B' means external lithium battery pack
188%	Battery Indicator	Indicates the remaining capacity of the current lithium battery pack
OUTPUT	Output Display	Turns on when AC or DC Output buttons are pressed
AC	Electric Supply Output	Turns on after AC Output button is pressed, indicating that AC ports are now available for use.
USB/CIG/DC	DC Output	Turns on after DC Output button is pressed, indicating that DC ports are now available for use.
	Lead-acid Battery Access	Indicates the connected lead-acid battery in correct voltage range
88 _V	Lead-acid battery nominal voltage	If it shows '12V', it indicates that the connected lead-acid battery nominal voltage is 12V. If it shows '24V', it indicates that the connected lead-acid battery nominal voltage is 24V.
>>>	Charge indication for lead-acid battery	Indicates charging of external lead-acid battery

Charging Your Lycan Powerbox

- Be sure to charge your Lycan Powerbox to 100% before operating. This will maximize battery life. For healthy battery maintenance, charge the Lycan once every two months. If the Lycan will not be used for an extended period of time, such as a month, remove the battery and properly store it until the Lycan is in use again.
- To decrease the recharge time of the Lycan it is recommended to disconnect any loads while recharging the unit.
- When the device is powered off, charging will cause it to power on and it will shut down when charging stops.
- During charging, the INPUT area on the LCD screen will be indicating the voltage and current information.
- INPUT voltage and current information will be available when the charging current is greater than 0.1A.

1/Charging via AC

- Charge the Lycan Powerbox with the provided AC charging cable. The AC icon will be displayed on the INPUT area of the LCD screen. This indicates the Lycan is charging with adapter.

WARNING

Never use a damaged cord. Electrical shock may occur if the AC cord is damaged or frayed. Only use the designated AC adapter and Lithium battery pack provided from the manufacturer

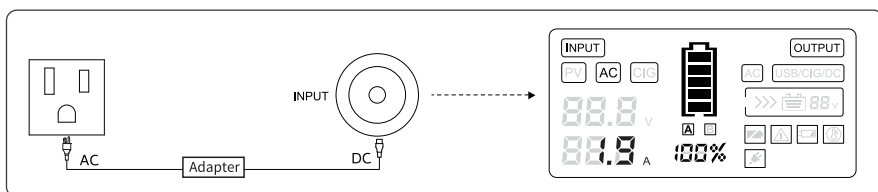

2/Charging via car

- Use the provided CIG to Anderson cable when charging via car. The CIG icon at the INPUT area of LCD screen will be displayed and indicates charging with 12V DC source from your car.

WARNING

Never use a damaged cord otherwise electrical shock may occur. Contact the manufacturer if the cord is damaged.

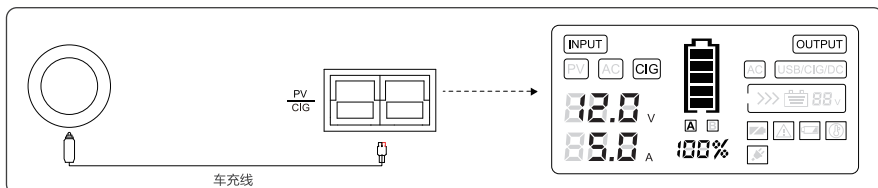

3/Charging via Solar

- Use the provided MC4 to Anderson Pole cable to connect external solar panels to the Lycan. Make sure to put the Lycan in a sunny place when charging via solar and place the solar panel in proper position without shade so as to maximize charging. Upon charging, the PV icon will be displayed on the LCD.
- PLEASE NOTE: The maximum wattage is 300W for charging via solar.

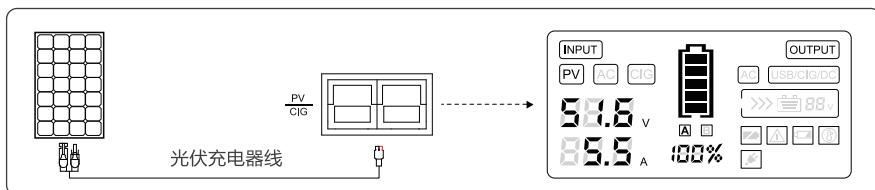

Using Your Lycan Powerbox

1 / AC MODE

- Short press the AC button on the main display to turn on the AC ports. There should be a green LED indicator letting the user know they can plug in AC devices. Additionally, the AC icon will be visible on the LCD display

CAUTION Keep 4 inches space on the back of the Lycan to guarantee heat dissipation of inverter

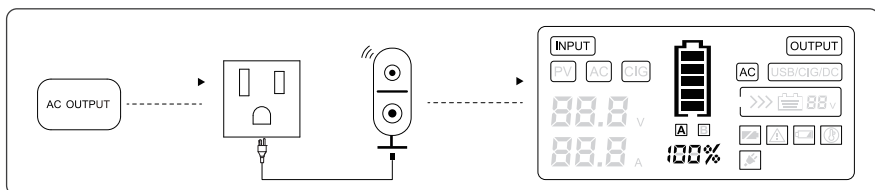



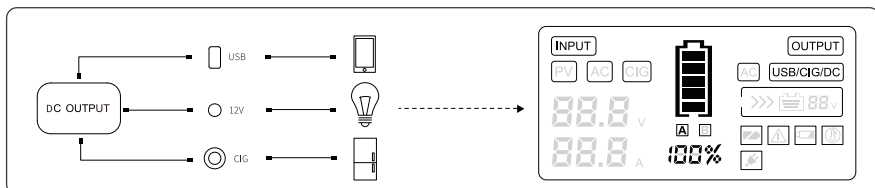

2 / DC MODE

- Short press the DC button on the main display to turn on the DC ports. There should be a green LED indicator letting the user know they can plug in DC devices. Additionally, the DC icon will be visible on the LCD display. 4 USB interfaces, 3 round 12V output interfaces and cigar lighter are available for use.



3/Charging External Lead Acid battery

- The Lycan is capable of charging both 12V and 24V lead acid batteries;
- When the lead acid battery is connected to the Lycan, the  icon will appear, and it will be distinguished if it is 12V or 24V in 5 seconds, and display with the respective icon  / 
- When charging is detected on the lead acid battery, the  on the LCD screen starts to flash. When it's detected that the charging current of lead acid battery is small, please check if fully charged, and turn off the output. Remove the current lead acid battery before next new output.

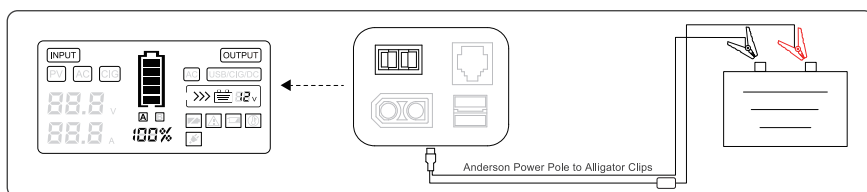

CAUTION

Do NOT start the vehicle engine when using the Lycan to charge a car battery, otherwise it may cause the device to be damaged and lead to serious incidents. When using the Lycan Powerbox to charge Lead Acid Battery, stop the charging process if the '12V' or '24V' displayed on the LCD is different from the actual voltage rating of the connected Lead Acid Battery.

Using LED Light

- Open the LED lighting board at top, turn the switch to control LED light ON/OFF; LED lighting is available in shutdown state.

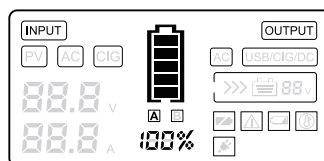
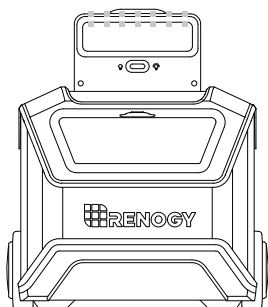

Using Internal and External Battery Pack

- The Lycan allows you to prepare a library of fully charged batteries for quick, hassle-free reloads. Now there is no waiting hours for the unit to recharge, simply swap it out for another battery and experience no power interruptions. In addition, charge external lithium batteries or even sealed lead acid batteries through the Lycan's unique design.

When charging, the Lycan charges the internal battery by default which will be denoted by the indicator A at the lower left of power icon keeps on.

- If charging an external battery pack, please make sure it is connected in via XT90 power cable interface and RJ45 network interface. In the interface area, push the switch to the left and the indicator B will be visible right of battery icon in LCD screen. The display will be geared towards external battery pack, and then the external battery pack is available for charging / discharging.

CONNECTION

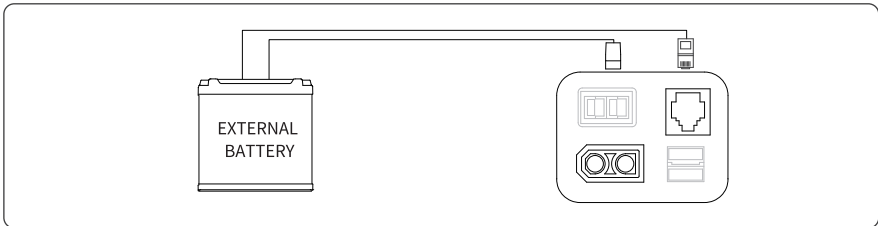

CHARGING-OVER

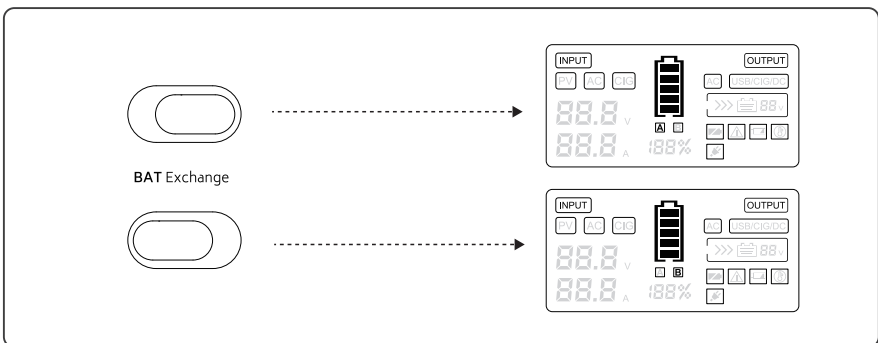

TECHNICAL SPECIFICATIONS

Battery	
Type	Lithium iron phosphate battery
Voltage	44.8V
Capacity	24AH
Cycle Life	2000 cycles to 80% capacity (80% DOD @25 C, Discharge rate: 1C)
Rated Charging Current	12A(Max15A)
Output Ports	
Inverter Wave Form	Pure Sine Wave
AC Outlet Voltage	110V (1200W Max)
USB DC Out	5V 2.4A(Max 7A ,4ports total)
CIG Out	12V(Max 150W)
DC Out	12V (Max 60W, 3 ports each)
Input Ports	
PV Input Voltage	12–72V PV MPPT
Maximum External PV Input Power	300W
General System	
Operating Temperature Range	-4 F to 113 F
Charging Temperature Range	32 F to 104 F
Storage Temperature Range	-4 F to 104 F
Operating / Storage Humidity	10%~90%
Method of Cooling	Fan
Dimensions	14.5 x 13.4 x 11.8 inches
Weight	55 lbs
Certifications / Standards	FCC UN38.3

MAINTENANCE

In order to extend equipment cycle life, please carry out daily maintenance.

■ Daily Maintenance

● 1/Operating Environment

In order to enhance the battery cycle life and equipment life, please keep away from harsh sunlight, water, dust and dirt. Do not leave the Lycan outside under harsh environments. The high temperature can lead to a chemical reaction inside the lithium battery which will damage the battery and decrease the cycle life.

● 2/Fault Alarm and Treatment

In case of fault alarm during operation, corresponding fault treatment methods shall be taken to avoid damage of equipment.

● 3/Charging / Discharging

Please charge the equipment regularly and avoid using large loads when battery capacity is low. The best time to recharge the equipment is when the battery capacity is at 40%. It's recommended to fully charge / discharge the battery once every month to extend battery life.

■ Component Replacement

All the components included in the Lycan are prone to wear and tear. Please make sure to replace any worn out parts, damaged wires or loose screws. If you are having issues replacing a part contact RENOGY or the supplier.

NOTE

Only trained personnel should be allowed to disassemble and replace the internal components. Before inspection and maintenance, please make sure the power is cut off and the battery switch is closed.

Do not leave objects inside the Lycan doing so may cause the unit to short circuit and can damage to the equipment.

Replacement of Internal Lithium Battery Pack

Please follow the steps below when replacing the internal lithium battery pack.

- Power off the equipment, remove all wires
- Remove the fastening screws on the upper case
- Remove the fastening screws on the back trolley, and remove the trolley
- Remove the upper case
- Remove the fastening screws on the fixing batten of lithium battery pack, and remove the batten
- Pull off the network cables and power cords of internal lithium battery pack
- Take out the lithium battery pack
- Put in the replacing lithium battery pack and install it

NOTE

Be careful when removing the upper case; do not pull off the internal connection line. Do not leave any equipment inside the Lycan when replacing the battery pack.

Replacement of Internal Lithium Battery Pack

- Remove the rubber stoppers and fastening screws on the upper case.
- Remove the rubber stoppers and fastening screws on the front interface.
- Remove the fastening screws on the back trolley, and remove the trolley.
- Remove the fastening screws on the fixing battens of lithium battery pack, and remove the batten.
- Disconnect XT-90 cable and RJ45 cable from the lithium battery.

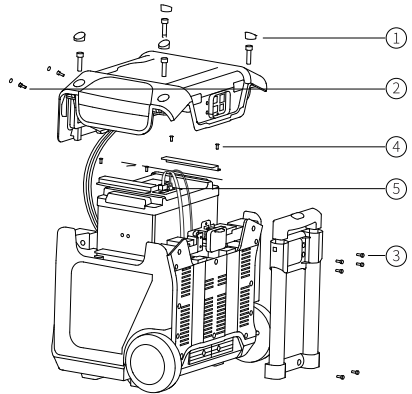

WARNING



Make sure the device is in shutdown state when replacing the lithium battery pack. Also make sure there is no flammable or explosive objects nearby.



Regular Maintenance

- In case the unit shuts down due to low battery voltage, charge the battery within 30 days to avoid any damage to the battery pack.
- If the Lycan will not be used frequently it's recommended to keep the battery power capacity within 45%~55% and store the unit in a clean, dry and ventilated environment with temperature of $77^{\circ}\text{F} \pm 41^{\circ}\text{F}$, humidity not higher than 75%, and to keep it away from corrosives, fire and heat sources.
- It is recommended to charge the battery to 100% then completely discharge it to 0% and then recharge it back to 45%-55% once every 6 months. This will help prolong battery life. If the battery capacity decreases abnormally please contact RENOZY or the supplier.
- Check all the connections, make sure there are no loose screws.
- Check all parts and cables, make sure to replace any worn out parts.
- Carry out regular cleaning of the air inlet, outlet and fan blades.

TROUBLESHOOTING

- In case the equipment does not operate normally after startup please refer to the following table to find the possible cause. At the same time, please check whether it is caused by the external environment, such as high/low temperature and humidity.
- Please contact RENOZY or the supplier for help if the following troubleshoot solutions do not work.

Fault	Cause	Solutions
LCD displays 	Abnormal Lithium battery pack	It indicates no communication with lithium battery 1、 Remove all electrical devices; 2、 Check whether the battery pack selector switch is in the correct position; 3、 Check whether the connection between the communication cable and the battery pack is fastened; 4、 Charge the equipment; 5、 Press the power button to restart the equipment; 6、 Turn off the LED light
LCD displays 	Equipment Failure	It indicates no communication with inverter 1、 Unplug any AC devices; 2、 Press the AC output control button to try to restart the inverter; 3、 Press the power button to restart the equipment

Fault	Causes	Solutions
LCD displays 	Lithium battery pack lowcapacity	It indicates battery low voltage. The inverter output will stop. Please charge the equipment.
LCD displays 	Over temperature of Lithium battery pack	It indicates battery high temperature. The inverter output will stop. Please disconnect any loads and turn off the unit.
LCD displays 	Abnormal alarm / fault of inverter	There will be no AC output 1、 Remove the AC devices; 2、 Press the AC output control button to try to restart the inverter; 3、 Press the power button to restart the equipment; 4、 The inverter may be over temperature protected, let the inverter cool down for a while
LCD is not on or with splash screen	Abnormal output of battery pack	1、 Remove all electrical devices; 2、 Check whether the battery pack selector switch is in the correct position; 3、 Check whether the connection between the communication cable and the battery pack is fastened correctly;
LED indicator of power button is not on	Battery pack not working	4、 Charge the equipment; 5、 Press the power button to restart the equipment; 6、 Turn off the LED light

FAQ

■ GENERAL

1.WHAT TYPE OF BATTERY IS IN THE LYCAN? WHAT’ S THE CYCLE LIFE OF THE LYCAN BATTERY?

The Lycan is equipped with a replaceable Lithium-Iron Phosphate (LFP) battery pack, one of the safest batteries in the market today. The battery pack is rated for 2000 cycles (80% DOD at 77 ℱ) and features an intelligent battery management system.

DISCHARGING

2. WILL MY DEVICES WORK ON THE LYCAN? CAN I OPERATE AC AND DC DEVICES AT THE SAME TIME?

Every device has a rated power value, typically rated in Watts (W). The Lycan's combined AC ports can run a maximum of 1200W continuously. If your device runs on less power than 1200W, then the Lycan will be able to work with your devices. In addition, you can operate both AC and DC devices at the same time. However, be mindful that the higher the wattage, the less time it will be able to run on the Lycan.

3. CAN I CHARGE OTHER BATTERIES WITH THE LYCAN? CAN THE LYCAN WORK AS A JUMP STARTER FOR MY VEHICLE?

A. Yes, the Lycan can charge 12V/24V Sealed Lead Acid Batteries.

B. No, the Lycan is not able to jump start a car. However, you can still use it to fully charge the car battery. It will shut down the output when the battery voltage reaches the set value.

4. HOW LONG DOES IT TAKE TO FULLY CHARGE MY LYCAN THROUGH AC POWER?

It takes 12 hours to fully charge the Lycan via AC power.

5. CAN I USE MY LYCAN'S AC & DC PORTS WHILE IT IS CHARGING?

Yes, the Lycan Powerbox integrates separate management systems so that you can charge and discharge at the same time.

MECHANICAL

6. WHAT MATERIAL IS THE LYCAN STRUCTURE MADE OF? IS THE PULL ROD RELIABLE?

The upper and lower case are made of reinforced ABS plastic, while the middle frame is structuralized sheet metal. The pull rod is fixed on the internal metal frame, ensuring stability and reliability of the structure.

7. HOW MUCH WEIGHT CAN I PUT ON THE LYCAN? CAN I SIT ON IT?

The Lycan is not recommended for sitting on. However, the maximum weight the Lycan can support is 165 lbs. of static weight. Be mindful that the LED is located on top of the Lycan and constant negligence may damage the LED or loosen parts.

SAFETY & PROTECTION

8. IS THE LYCAN WATERPROOF?

The Lycan is not waterproof. It has an IP23 rating and is spray proof while the interface door closed.

9. WHAT TYPE OF ELECTRONIC PROTECTIONS DOES THE LYCAN HAVE?

The Lycan is equipped with the following electronic protections: Charging circuit — Overcharge and over voltage; Discharging circuit — Over-discharge and low voltage; Battery — Overcharge, over-discharge, and short circuit.

SUPPORT

10. HOW DOES THE WARRANTY WORK? CAN I REPLACE THE BATTERY IN MY LYCAN POWERBOX?

A. The Lycan has a 1 year material and workmanship warranty.

B. Yes, the battery is replaceable. Please follow our battery replacement guide.



2775 E. Philadelphia St., Ontario, CA 91761

1-800-330-8678

Renogy reserves the right to change the contents of this manual without notice.