

Solar Suitcase

Renogy 100W Solar Suitcase w/ Voyager





Version 1.0



Important Safety Instructions

Please save these instructions.

This manual contains important safety, installation, and operating instructions for the charge controller. The following symbols are used throughout the manual to indicate potentially dangerous conditions or important safety information.

- | | |
|--|---|
|  WARNING | Indicates a potentially dangerous condition. Use extreme caution when performing this task |
|  CAUTION | Indicates a critical procedure for safe and proper operation of the controller |
|  NOTE | Indicates a procedure or function that is important to the safe and proper operation of the controller. |

General Safety Information

- Read all the instructions and cautions in the manual before beginning the installation.
- There are no serviceable parts for this controller. Do NOT disassemble or attempt to repair the controller.
- Make sure all connections going into and from the controller are tight.

■ Battery Safety

- Use only sealed lead-acid, flooded, gel or lithium batteries which must be deep cycle.
- Explosive battery gases may be present while charging. Be certain there is enough ventilation to release the gases.
- Be careful when working with large lead acid batteries. Wear eye protection and have fresh water available in case there is contact with the battery acid.
- Carefully read battery manuals before operation.
- Do NOT let the positive (+) and negative (-) terminals of the battery touch each other.
- Recycle battery when it is replaced.
- Over-charging and excessive gas precipitation may damage the battery plates and activate material shedding on them. Too high of an equalizing charge or too long of one may cause damage. Please carefully review the specific requirements of the battery used in the system.
- Equalization is carried out only for non-sealed / vented/ flooded / wet cell lead acid batteries.
- Do NOT equalize sealed / VRLA type AGM / Gel cell batteries UNLESS permitted by battery manufacturer.

Table of Contents

General Information	04
Included Components	06
Identification of Parts	07
Installation	09
Operation	11
Selecting Battery Type	11
AMP/VOLT Button	11
LED Display	12
System Status Icons	12
LED Behavior	12
LED Error Behavior	13
System Status Troubleshooting	13
Maintenance	14
Frequently Asked Questions	15
Technical Specifications	16
Solar Panel Parameters	16
Charge Controller Parameters	16
Battery Charging Parameters	17
Dimensions	18

General Information

The Renogy Solar Suitcase combine highly efficient monocrystalline solar panels with a 10A Voyager charge controller to create an easy-to-use, 'plug and play' system.

This system is specifically designed for mobile off-grid applications, where space and weight limitations are abundant. The Solar Suitcase models support 12V deep cycle battery varieties such as Lithium, sealed-lead acid, gel, and flooded. With built-in tilting stands, these panels can be adjusted at different angles to maximize the power output throughout the seasons.

The alligator clips included in this package make it easy to connect the panel to a battery in seconds. If one ever needs to connect a battery with a different type of end terminal, the alligator clips are attached via MC4 Connectors.

Key Features

- Easy to read LCD displaying solar charge information.
- 6 Battery Type Compatible – LiFePO4, LTO, Gel, AGM, Flooded, and Calcium.
- 5 Stage PWM charging: Soft-charge, Bulk, Absorption, Float, and Equalization.
- Temperature compensation and correcting the charging and discharging parameters automatically, improving battery lifetime.
- Protection against: reverse polarity and battery connection, reverse current from battery to solar panel protection at night, over-temperature, and over-voltage.
- Positive ground charge controller.
- Tilting stand for maximum solar generating potential.
- Convenient storage case for easy transportation.

PWM Technology

The Voyager utilizes Pulse Width Modulation (PWM) technology for battery charging. Battery charging is a current based process so controlling the current will control the battery voltage. For the most accurate return of capacity, and for the prevention of excessive gassing pressure, the battery is required to be controlled by specified voltage regulation set points for Absorption, Float, and Equalization charging stages. The charge controller uses automatic duty cycle conversion, creating pulses of current to charge the battery. The duty cycle is proportional to the difference between the sensed battery voltage and the specified voltage regulation set point. Once the battery reached the specified voltage range, pulse current charging mode allows the battery to react and allows for an acceptable rate of charge for the battery level.

Five Charging Stages

The Voyager has a 5-stage battery charging algorithm for a rapid, efficient, and safe battery charging. They include: Soft Charge, Bulk Charge, Absorption Charge, Float Charge, and Equalization.

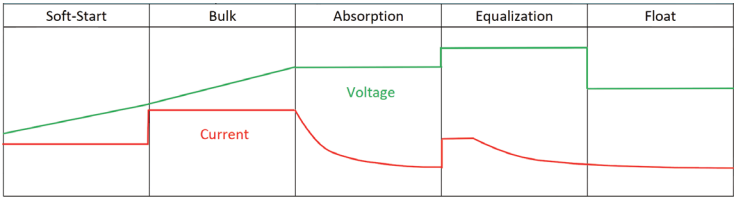

Soft Charge: When batteries suffer an over-discharge, the controller will softly ramp the battery voltage up to 10V.

Bulk Charge: Maximum battery charging until batteries rise to Absorption Level.

Absorption Charge: Constant voltage charging when battery is over 85% for lead acid batteries. LiFePO₄, and LTO batteries close to fully charging after absorption stage, the absorption level will reach 14.4V for LiFePO₄, and 14.0V for LTO batteries.

Equalization: Only for Flooded or Calcium batteries drained below 11.5V will automatically run this stage and bring the internal cells as an equal state and fully complement the loss of capacity. LiFePO₄, LTO, Gel and AGM do not undergo this stage.

Float Charge: Battery is fully charged and maintained at a safe level. A fully charged lead acid battery (Gel, AGM, Flooded) has a voltage more than 13.6V; if the lead acid battery drops to 12.8V at float charge, it will return to Bulk Charge. LiFePO₄, and LTO have NO float charge. If a LiFePO₄ or LTO battery voltage drops to 13.4V after Absorption Charge, it will return to Bulk Charge.



Incorrect battery type setting may damage your battery.



Over-charging and excessive gas precipitation may damage the battery plates and activate material shedding on them. Too high of equalizing charge or for too long may cause damage. Please carefully review the specific requirements of the battery used in the system.

Included Components



MC4 to Alligator Clips w/ Fuse

Used for connecting charge controller to battery. The entire cable from the charge controller to the alligator clips measures 9.9 feet with an in-line fuse of 10A.

Optional Components

Optional components that require a separate purchase:



Remote Temperature Sensor

Measures the temperature at the battery and uses this data for very accurate temperature compensation. The sensor is supplied with a 19.5ft cable length that connects to the charge controller.

Identification of Parts

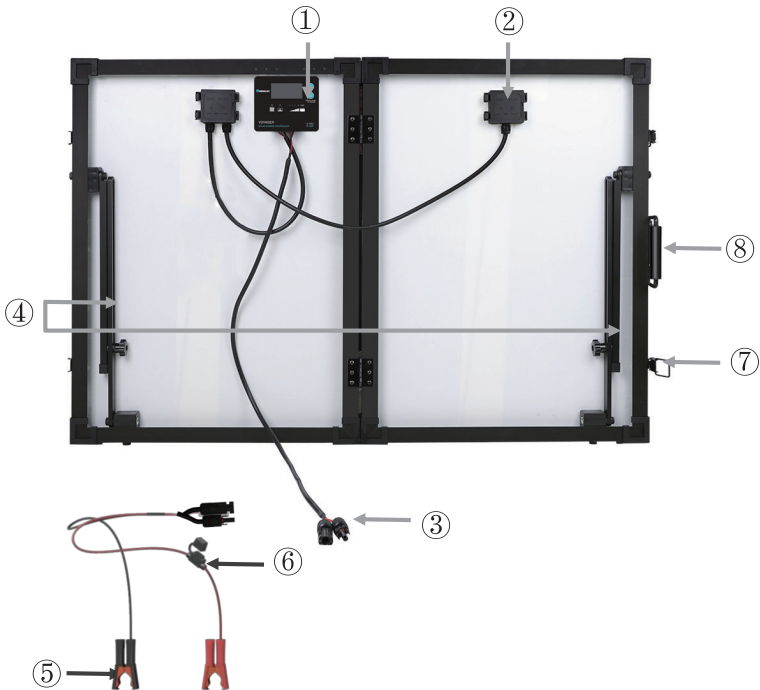

Key Parts

1. 10A VoyagerPG Charge Controller
2. Junction Box
3. MC4 Connectors
4. Tilt Stands
5. Battery Alligator Clips
6. In-line fuse (10A)
7. Latch
8. Handle
9. Case (Not pictured)

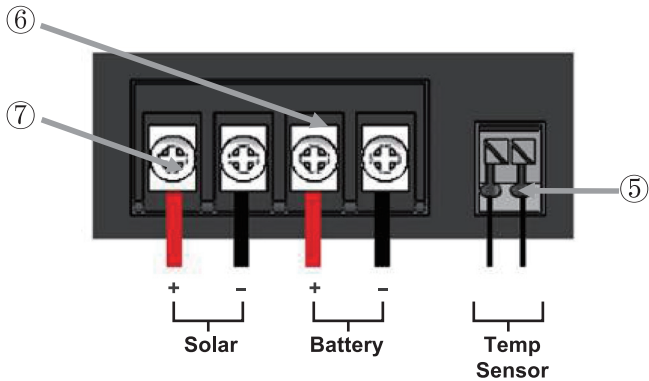
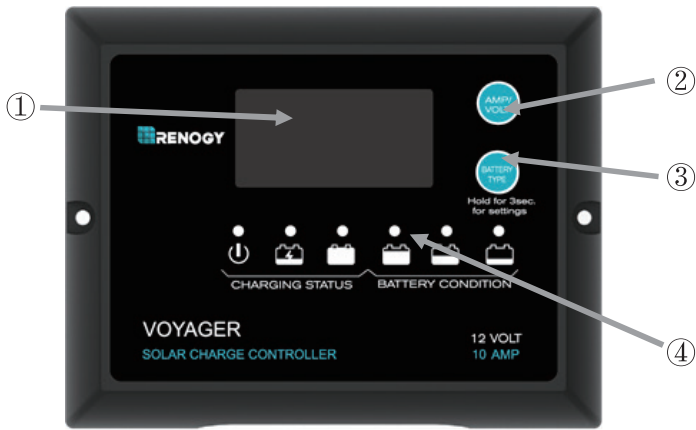

Key Parts

1. Backlit LCD
2. AMP/VOLT Button
3. BATTERY TYPE Button
4. LED Bar
5. Remote Temperature Sensor Port (optional accessory)
6. Battery Terminals
7. Solar Terminals

Installation

1. Unlatch and unfold unit then connect MC4 Connectors

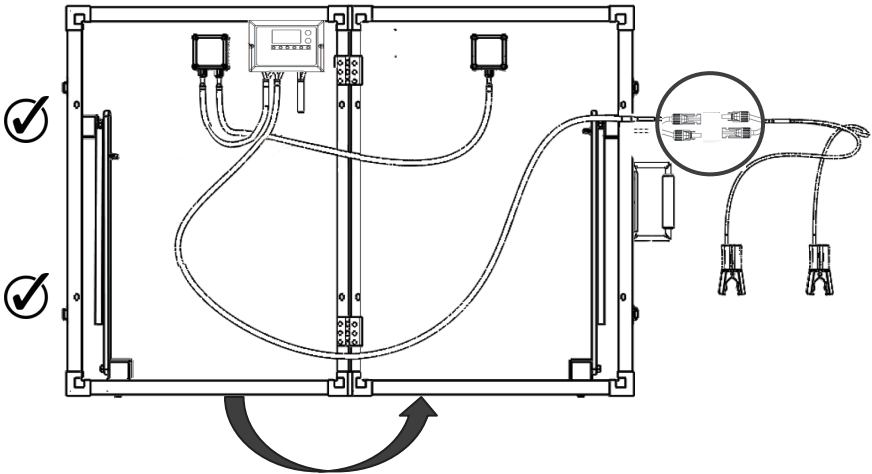

2. Connect Battery Alligator Clips to 12V Battery

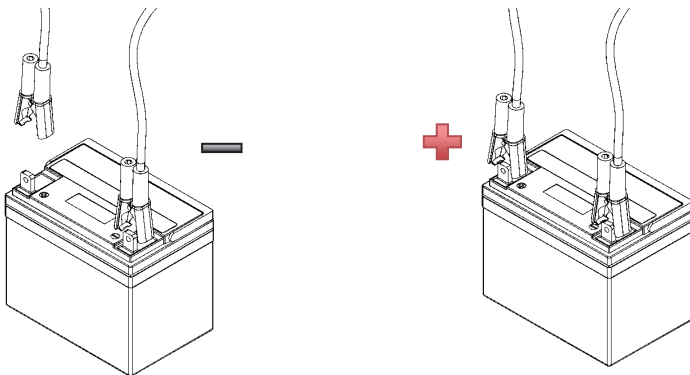

3. Unscrew butterfly nut tilt to desired angle and lock butterfly nut

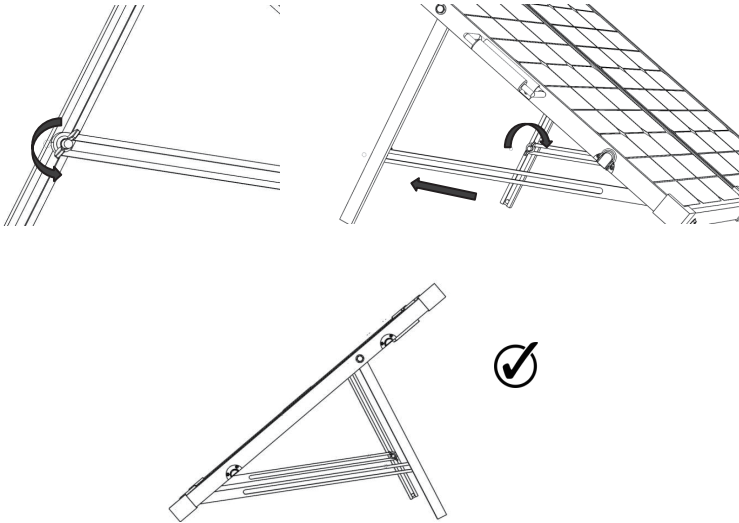

To maximize the output, adjust the angle of the suitcase regularly to track the sun's movement throughout the season

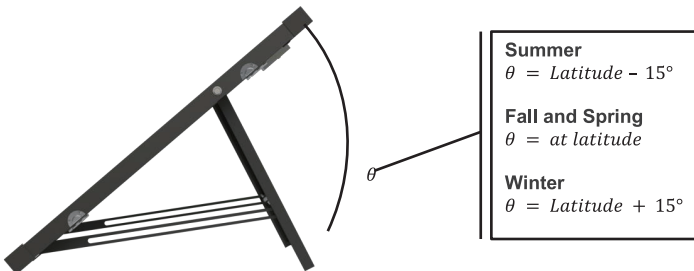

Operation

When the controller powers on, the Voyager will run a self-quality check mode and automatically display the figures on LCD before going into auto work.

888	Self-test starts, digital meter segments test
200	Software version test
120	Rated voltage Test
200	Rated Current Test
25	External battery temperature sensor test (if connected)

Selecting Battery Type

WARNING

Incorrect battery type setting may damage your battery. Please check your battery manufacturer's specifications to when selecting battery type.

The Voyager provides 6 battery types for selection: LiFePO₄, LTO, Gel, AGM, Flooded, and Calcium Battery.

Press and hold the BATTERY TYPE Button for 3 seconds to go into battery selection mode. Press the BATTERY TYPE Button until the desired battery is displayed. After a few seconds, the highlighted battery type will automatically be selected.

NOTE

LiFePO₄ battery indicates Lithium-iron Phosphate or LFP Battery

LTO Battery indicates Lithium Titanate Oxidized, Li₄Ti₅O₁₂ Battery

AMP/VOLT Button

Pressing the AMP/VOLT Button will sequence through the following display parameters: Battery Voltage, Charging Current, Charged Capacity (Amp-hour), and Battery Temperature (if external temperature sensor connected)

Normal Sequencing Display

The following is an alternative display voltage for when the battery is Fully charged

LED Display



System Status Icons







LED Behavior

	LED Indicators					
LED Color	RED	BLUE	GREEN	GREEN	Yellow	RED
Soft-start charging	ON	FLASH	OFF	OFF	OFF	ON
Bulk charging (BV < 11.5V)	ON	ON	OFF	OFF	OFF	ON
Bulk charging (11.5V < BV < 12.5V)	ON	ON	OFF	OFF	ON	OFF
Bulk charging (BV > 12.5V)	ON	ON	OFF	ON	OFF	OFF
Absorption charging	ON	ON	OFF	ON	OFF	OFF
Float charging	ON	OFF	ON	OFF	OFF	OFF
Solar weak (Dawn or Dusk)	FLASH	OFF	OFF	Subject to battery voltage		
At Night, no charge	OFF	OFF	OFF	Subject to battery voltage		

NOTE

BV = Battery Voltage

LED Error Behavior

LED Indicators								
							Error Code	Screen
LED Color	RED		GREEN	GREEN	Yellow	RED		
Solar good, BV < 3V	ON	OFF	OFF	OFF	OFF	FLASH	'b01'	FLASH
Solar good, battery reversed	ON	OFF	OFF	OFF	OFF	FLASH	'b02'	FLASH
Solar good, battery over-voltage	ON	OFF	OFF	FLASH	FLASH	FLASH	'b03'	FLASH
Solar off, battery over-voltage	OFF	OFF	OFF	FLASH	FLASH	FLASH	'b03'	FLASH
Solar good, battery over 65°C	ON	OFF	OFF	FLASH	FLASH	FLASH	'b04'	FLASH
Battery good, solar reversed	FLASH	OFF	OFF	According to BV			'PO1'	FLASH
Battery good, solar over-voltage	FLASH	OFF	OFF				'PO2'	FLASH
Over Temperature Protection							'otP'	FLASH

System Status Troubleshooting

Description	Troubleshoot
Battery over voltage	Use a multi-meter to check the voltage of the battery. Make sure the battery voltage is not exceeding the rated specification of the charge controller. Disconnect battery.
Charge controller does not charge during daytime when the sun is shining on the solar panels.	Confirm that there is a tight and correct connection from the battery bank to the charge controller and the solar panels to the charge controller. Use a multi-meter to check if the polarity of the solar modules have been reversed on the charge controller's solar terminals. Look for error codes

Maintenance

For best controller performance, it is recommended that these tasks be performed from time to time.

1. Check wiring going into the charge controller and make sure there is no wire damage or wear.
2. Tighten all terminals and inspect any loose, broken, or burnt up connections.
3. Occasionally clean the case using a damp cloth.

Frequently Asked Questions

Q. Can the kit charge two or more 12V batteries connected in parallel?

A. Yes, it's possible if the batteries have the same type and capacity and are wired in parallel as a single 12V battery bank.

Q. Is there any risk that the solar kit will over charge my battery?

A. One of the functions of the solar charge controller is to ensure that your battery is not over charged; therefore there is no risk of overcharge.

Q. Can I extend the battery leads?

A. Yes, it's possible – please choose the same size of cable for extension. However, there longer the extension, the greater the line loss. Bigger gauge will be required for longer runs.

Q. Do I need to clean the solar panels?

A. Yes, it is recommended for better performance. Dust and dirt should first be swept off the panel surface using a soft brush. When the sweeping is complete, use a wet cloth to wipe the panel surface to remove remaining dirt and grime.

Q. Can rain damage the solar kit?

Most of the components are IP rated certified. The charge controller and MC4 connector are IP67 rated, junction box is IP65 rated.

Technical Specifications

Solar Panel Parameters

Description	100W Parameters
Maximum Power	100 W
Open Circuit Voltage (Voc)	21.6 V
Short Circuit Current (Isc)	6A
Maximum Power Voltage (Vmp)	18.0 V
Maximum Power Current (Imp)	5.56 A
Cell Type	Monocrystalline
Operating Temperature	-40°F to +185°F
Folded Size	19.9 x 27.2 x 2.8 inches
Net Weight	26.6 lbs

Charge Controller Parameters

Electrical Parameters	
Model Rating	10A
Normal Battery Voltage	12V
Maximum Solar Voltage(OCV)	25V
Maximum Battery Voltage	17V
Rated Charging Current	10A
Battery Start Charging Voltage	3V
Electrical Protection and Feature	Spark-free protection. Reverse polarity solar and battery connection Reverse current from battery to solar panel protection at night Over temperature protection with derating charging current Transient overvoltage protection, at the solar input and battery output protects against surge voltage
Grounding	Common Negative
EMC Conformity	FCC Part-15 class B compliant;EN55022:2010
Self-consumption	< 8mA
Electrical Parameters	
Dimensions	L5.12*W4.02*H1.06 inches
Weight	0.88 lbs.
Mounting	Vertical Wall Mounting
Ingress Protection Rating	IP65
Maximum Terminals Wire Size	10AWG (5 mm ²)
Terminals Screw Torque	13 lbf·in
Operating Temperature	-4°F to +122°F
Storage Temperature Range	-40°F to +185°F Temp.
Temp. Comp. Coefficient	-24mV / °C
Temp. Comp. Range	-4°F ~ 122°F
FOperating Humidity	100% (No condensation)

Battery Charging Parameters

Charging Stages						
Soft-Charge	Output battery voltage is 3V-10VDC, Current = half of the solar panel current					
Bulk	10VDC to 14VDC Current = Rated Charge Current					
Absorption @ 25°C	Constant voltage until current drops to 0.75/1.0 amps and holds for 30s. Minimum 2 hours charging time and maximum 4 hours time out If charging current < 0.2A, stage will end.					
	LiFePO4 14.4V	LTO 14.0V	GEL 14.1V	AGM 14.4V	WET 14.7V	CALCIUM 14.9V
Equalization	Only Wet (Flooded) or Calcium Batteries will equalize, 2 hours maximum Wet (Flooded) = if discharge below 11.5V OR every 28 days charging period. Calcium = every charging cycle					
	Wet (Flooded) 15.5V			Calcium 15.5V		
Float	LiFePO4 N/A	LTO N/A	GEL 13.6V	AGM 13.6V	WET 13.6V	CALCIUM 13.6V
Under Voltage Recharging	LiFePO4 13.4V	LTO 13.4V	GEL 12.8V	AGM 12.8V	WET 12.8V	CALCIUM 12.8V

Dimensions

■ Voyager

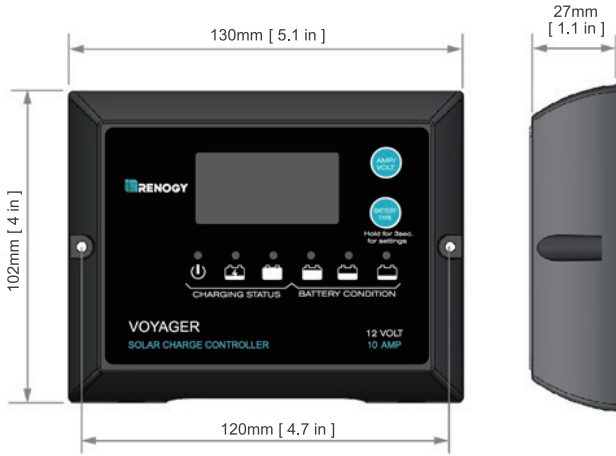

■ 100W Suitcase

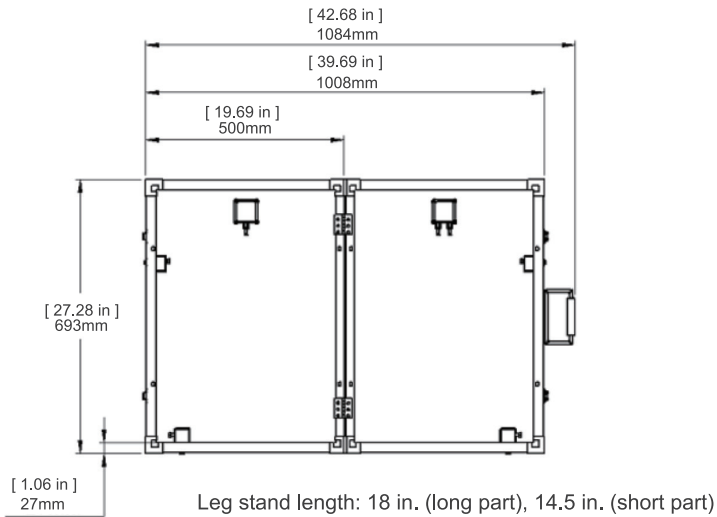



2775 E. Philadelphia St., Ontario, CA 91761

1-800-330-8678

Renogy reserves the right to change the contents of this manual without notice.