

Rechargeable Lithium battery

Operation and Maintenance manual



Product Model: SG48200T Product

Specifications: 51.2V 200Ah

Content

1. Information	1
1.1 Validity	1
1.2 Target Group	1
1.3 Levels of warning messages	1
1.4 Symbol Description	2
1.5 Abbreviation Description	3
2. Safety	5
2.1 Safety precautions	5
2.2 Safety instructions	6
2.2.1 Safety gear	6
2.2.2 Emergency safety measures	6
2.2.3 Other Tips	7
3.1 Introduction	8
3.2 Features	9
3.3 Specification	10
3.3.1 Dimension	10
3.3.2 Parameters	10
3.3.3 Panel Interface	11
3.4 Protection function	15
4 Installation	17
4.1 Preparation	17
4.1.1 Safety Compliance	17
4.1.2 Environment	17
4.1.3 Tools	17
4.2 Inspection	19
4.2.1 Unpacking	19
4.2.2 Scope of delivery	19
4.3 Start Installation	21
4.3.1 Remainder	21
4.3.2 Procedures	22
4.3.3 Tips	25
5. Cable connection and commissioning	26
5.1 Get battery ready	26
5.2 Grounding cable connection	26
5.3 Communication cable connection	26
5.4 DC power cable connection	27
5.5 Connecting with inverter	27
5.6 Commissioning	30
5.7 Switch off battery	31
5.7.3 Turn off all batteries signal switch	31
6 Troubleshooting and FAQ	32
7. Transport, Storage	34

8.Disposal of battery34
Appendix I 35

1. Information

1.1 Validity

This document is valid for: SG48200T Battery Pack.

1.2 Target Group

This document is intended for qualified persons and operators. Only qualified persons are allowed to perform the activities marked in this document with a warning symbol and the caption "Qualified person".

Qualified persons must have the following skills:

- Knowledge of how lithium iron phosphate batteries work and are operated.
- Knowledge of how an energy storage system (including PV/battery/hybrid inverter, MPPT, Meter, Distribution box etc.) works and is operated.
- Knowledge of local applicable connection requirements, standards, and directives.
- Training in the installation and commissioning of electrical devices, batteries.
- Training in how to deal with the dangers and risks associated with installing, repairing and using electrical devices, batteries.

1.3 Levels of warning messages

The following levels of warning messages may occur when handling the product

⚠ DANGER

Indicates a hazardous situation which, if not avoided, will result in death or serious injury.

⚠ WARNING

Indicates a hazardous situation which, if not avoided, could result in death or serious injury.

⚠ CAUTION



Indicates a hazardous situation which, if not avoided, could result in minor or moderate injury or product permanent damage.





⚠ NOTICE

Indicates a situation which, if not avoided, can result in property damage or product not work or accelerated product damage



1.3 Symbol Description

1.4.1 Symbols on products label

Label	Definition
	Beware of electrical shock
	Do not place the battery within children/pet touchable area.
	Do not place the battery near heat source and flammable material

	Do not expose the battery to direct sunlight, rain and snow.
	Do not short circuit the battery
	Recycle label
	WEEE designation

1.4.2 Other symbols

Label	Definition
 Qualified person	Indicates activities that can only be performed by qualified persons
	Grounding point

1.5 Abbreviation Description

Abbreviation	Definition
Battery/battery pack/battery module	Single SG48200T rechargeable lithium iron phosphate battery pack including cells, BMS and enclosure etc.
Battery system/cluster	Multiple SG48200T battery pack connected in parallel with power, communication and grounding cables and installation auxiliaries.
BMS	Battery management system Electronical Unit to ensure lithium cells' safety and display information or control the battery work mode.
SOC	State of charge The battery state of charge refers to the percentage of the

	remaining capacity and rated capacity of the battery.
SOH	State of health The battery health status refers to the percentage between the full charged capacity and the rated capacity of the battery.
DIP switch	Dual in-line package switch
COCP	Charge over current protection
DOCP	Discharge over current protection
COVP	Cell over voltage protection
POVP	Pack over voltage protection
CHTP	Charge high temperature protection
DHTP	Discharge high temperature protection
CUVP	Cell under voltage protection
PUVP	Pack under voltage protection
CLTP	Charge high temperature protection
DLTP	Discharge high temperature protection
SCP	Short circuit protection
LCD	Liquid Crystal Display

2. Safety

2.1 Safety precautions

DANGER

Explosion risk

- Do not impact the battery with heavy objects.
- Do not squeeze or pierce the battery pack.
- Do not throw the battery pack into the fire.

WARNING

Fire risk

- Do not expose the battery pack to the condition over 80°C.
- Do not put the battery near a heat source, such as a fireplace.
- Do not expose the battery pack to direct sunlight or raining.

CAUTION

Electric shock risk

- Do not allow non-qualified person to disassemble the battery pack.
- Do not touch the battery pack with wet hands.
- Do not expose the battery pack to moisture or liquid environment.

NOTICE

Damage risk

- Do not short-circuit or reverse connect the battery.
- Do not use chargers or charging devices unapproved by the manufacturer to charge the battery.
- Do not mix batteries from different manufacturers or different kinds, types or brands.

2.2 Safety instructions

The battery has been designed and tested in accordance with international (such as UN38.3 etc.) safety requirements. However, due to various factors during the whole lifetime process, Manufacturer cannot guarantee absolute safety, in order to prevent personal injury and property damage and ensure long-term operation of the battery, please do read the below section carefully to operate the battery and handle emergency situations.

2.2.1 Safety gear

It is required to wear the following safety gear when installing and handling the battery pack.



Insulated gloves



Safety Glasses



Safety Shoes

2.2.2 Emergency safety measures

Water invasion

Please cut off the AC power supply of the system first and then disconnect all switched under the premise of ensuring safety.

Electrolyte or gas leakage

If the battery pack leaks electrolyte, avoid contact with the leaking liquid or gas. If one is exposed to the leaked substance, immediately perform the actions described below.

- Gas Inhalation: Evacuate the people in the contaminated area and seek medical aid immediately.

- Eye Contact: Flush your eye with clean and flowing water for 15 min, and seek medical aid immediately.
- Skin Contact: Thoroughly rinse the exposed area with soap and water to be sure no chemical or soap is left on them, and seek medical aid immediately.
- Ingestion: Induce vomiting, and seek medical help immediately.

 **WARNING**

In case of fire situations, please use carbon dioxide fire extinguisher rather than liquid to put out fires.

2.2.3 Other Tips

- All the product are strictly inspected before shipment, please contact your supplier for replacement if you notice there's any defectives such as swelling.
- Do not disassemble batteries and components, otherwise the manufacturer will not be responsible for any damage caused by unauthorized disassembly or repair.
- Do enable the battery to be safely grounded before use to make sure the system in safe and normal operation.
- Please ensure that the electric parameters of these devices are compatible mutually before connecting the battery to other devices.
- Please take the environmental factors into careful considerations to ensure that the system can work in a suitable condition as the environment and storage methods have a certain impact on the service life and reliability of this product.

3. Product Overview

3.1 Introduction

The SG48200T battery is designed for residential application and works as a storage unit in the photovoltaic system. It is a 51.2V lithium battery system, with BMS inside. It could be operated in both on-grid, back-up and off-grid modes with compatible inverters. Below is the general schematic of an ac-coupled system with the batteries.

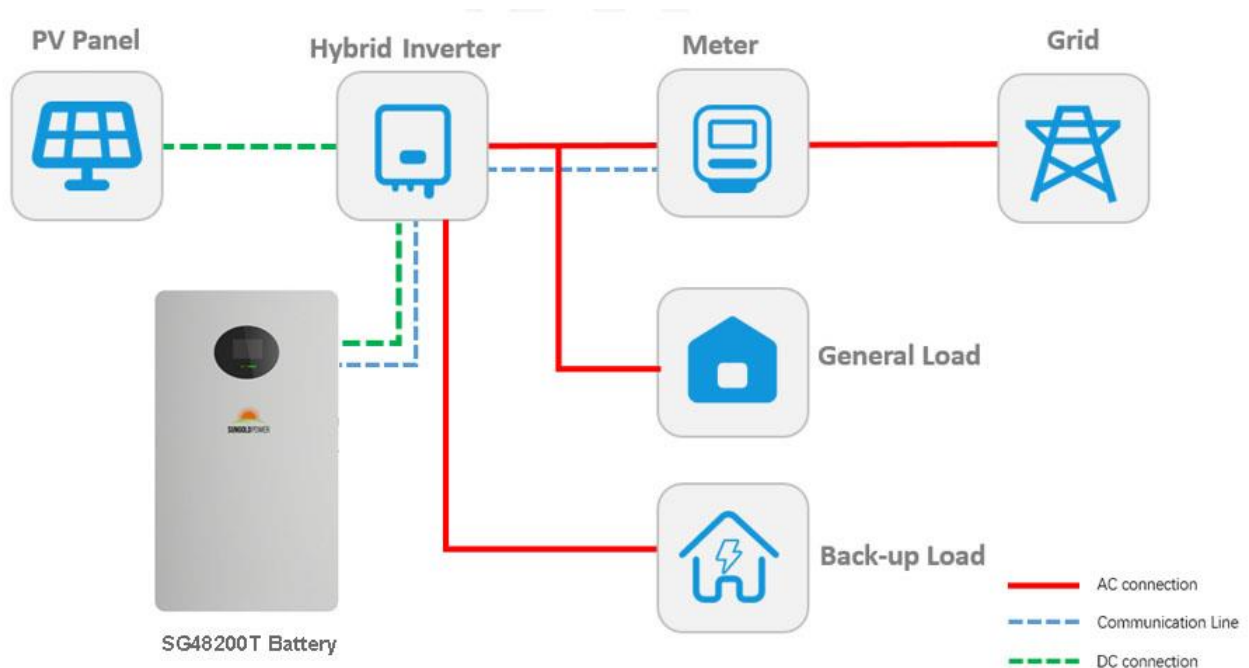

⚠ CAUTION

This electrical connection in this diagram is only for illustration, please follow the Manual suggestions of related devices and operate in accordance with locally

3.2 Features

- Highest safety, battery is made from LiFePO₄ chemistry and comply with highest international safety and transport standard.
- Modular and flexible, support up to 32 batteries connect together to expand the system energy.
- Built-in pre-charge circuit to avoid rush current when connecting with different inverter/chargers.
- Automatic dynamic addressing function when connected multiple batteries together.
- Support a maximum of 96% DOD under off-grid and back-up application
- Built in BMS provide warning and protection functions including over-discharged, over-charged, over-current, short-circuit and high/low temperature.
- LiFePO₄ as cathode material and automatic balancing function to meet longer cycle life
- Compact size and light weight for easy installation and maintenance.
- Multiple installation bracket to adopt with different customers' requirement.
- LED display, CAN/RS485 port for external communication and upgrade the BMS firmware.
- Rapid shut down function for North American market.
- Equipped with LCD to view battery information.

3.3 Specification

3.3.1 Dimension

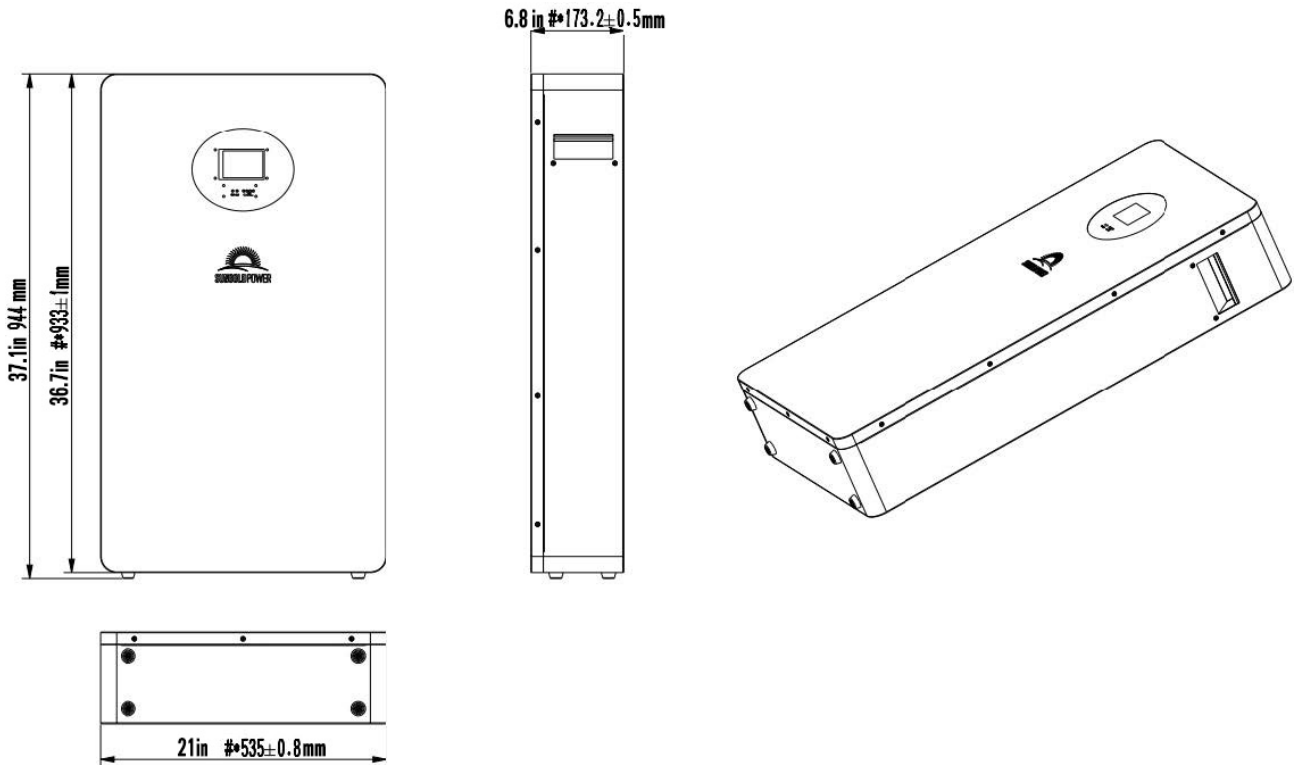

3.3.2 Parameters

Items	SG48200T
Rated voltage	51.2V
Max. voltage range	44.8~57.6V, Shipping voltage>51.2V
Charge voltage	56.0V
Float charge voltage	54.6V
Nominal energy@0.5c	10.24KWh
Usable energy@0.5c	9.84kWh
Nominal capacity@0.5c	200Ah
Dimension	21.1* 37.2*6.8 inch (535*944*173mm)
Weight	~198.4lb (90kg)
Standard charge current	≤100A
Max. charge current	140A
Standard discharge current	≤100A

Max. discharge current	200A (initial temp. ≤86°F (30°C))	
Peak discharge current	200~240A@5mins 240~300A@15S	
Communication	RS485 /CAN	
Max parallel number	32pcs	
Operation temperature ¹	Charge: 32°F to 122°F (0~50°C) Discharge:14°F to 122°F (-10~50°C)	
Storage temperature @off mode	32°F(0°C)<T<86°F(30°C)	< 6 months
	14°F(-10°C)<T<113°F(45°C)	< 3 months
	Recommended environment	59°F to 95°F (15~35°C), 5~75%RH

NOTICE

The optimum operating temperature range is from 59°F to 86°F (15°C to 30°C), Frequent exposure to the harsh temperatures may worsen the performance of the battery pack and cycle life.

3.3.3 Panel Interface

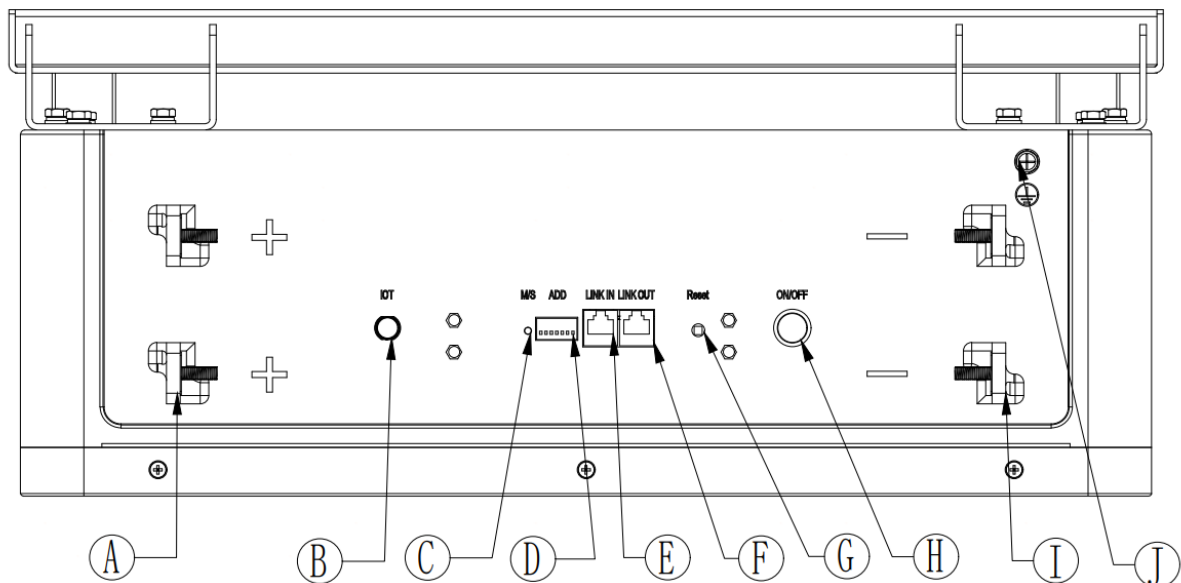

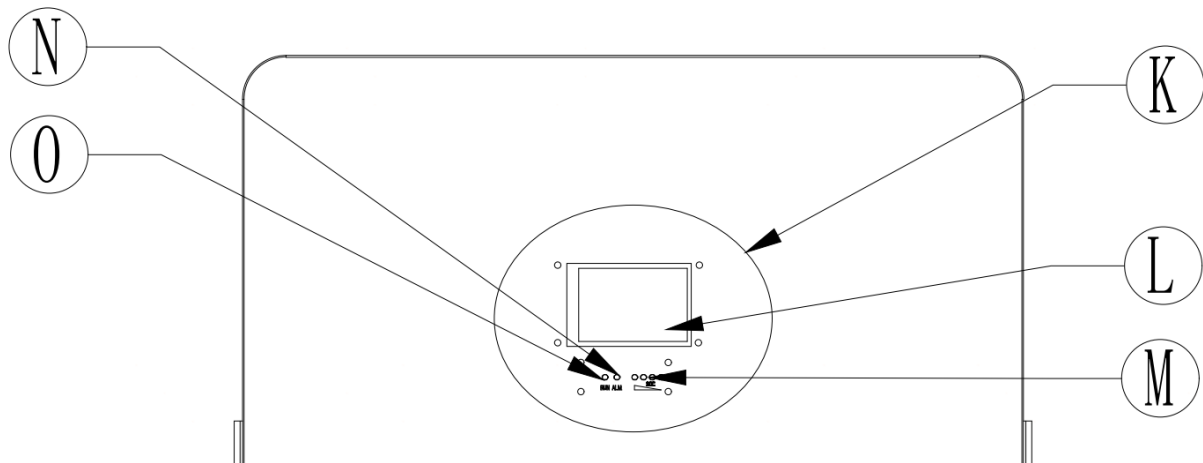

No.	Items	Usage description	Remark
A	Positive terminal	Used to connect the inverter/charger	
B	IOT	Used to connect with cloud platforms	
C	M/S	Used to indicate the module is Master or Slave battery	Single mode: OFF Parallel mode: ON- Master battery OFF- Slave battery
D	DIP	Used to set the RS485 baud rate and inverter protocol choosing	
E	Link IN	For internal and external communication	
F	Link OUT		
G	Reset	Used to sleep(3s)/awake(3s)/reset(6~10s) BMS in power on mode.	
H	Power switch	Used to Power on/off battery	
I	Negative terminal	Used to connect the inverter/charger	
J	Ground	Used to connect battery with ground	
K	PET	Decorative film	
L	LCD	Used to show battery information	
M	SOC	Used to show battery real-time SOC	Please see 3.3.3.3 for flashing specifications
N	ALM	Used to show battery Alarm/Protection status	
O	RUN	Used to show battery is in running status when lighting or flashing	

3.3.3.1 G: Link IN / Link OUT

Port	Pin No.	Definition	Remarks
Link IN	1	RS485-B1	1.Used to connect with external devices to establish communication. 2.Used to connect with upper battery pack Link OUT.
	2	RS485-A1	
	3	SGND	
	4	CAN-H	
	5	CAN-L	
	6	SGND	
	7	RS485-A1	
	8	RS485-B1	
Link OUT	1	RS485-B2	Used to connect with downward battery pack Link IN.
	2	RS485-A2	
	3	SGND	
	4	CAN-H	
	5	CAN-L	
	6	SGND	
	7	RS485-A2	
	8	RS485-B2	

3.3.3.2: DIP addressing

DIP							Remarks
RS485 baud rate	Undefined				Protocol		
1	2	3	4	5	6	7	
ON: 115200	Reserved for multiple cluster parallel and other future function				0	0	Protocol ID0
OFF: 9600					1	0	Protocol ID1
					0	1	Protocol ID2
					1	1	reserved
Keep all batteries the same setting	Keep default setting				Master: according to inverter Brand Slave: keep default setting		

Note:

Only master battery needs to set the Protocol ID, keep all slave battery default setting, after choose the protocol ID, the battery will auto detect the inverter information and corresponding to get into running, restart to take effect after setting new DIP sequence.

CANbus Connection		RS485 Connection		DIP setting (Master battery)
Protocol ID	INVERTER	Protocol ID	INVERTER	
CAN 1	Victron/SMA/Studer Innotec/Sofar	RS485 1	SUNGOLDPOWER SPH Voltronic/RCT/ MPP/Alpha outback/ Phocos	 X000000
CAN 2	SUNGOLDPOWER SG/ SolArk/Solis/Goodwe/Deye/ Growatt/SAJ/LUXPOWER/ Megarevo/INVT/Sermatec/ MUST/Sunsynk	RS485 2	SUNGOLDPOWER SPH	 X000010
CAN 3	Schneider	RS485 3	LUX POWER	 X010001

NOTICE

Fail to follow the DIP switch setting will cause the communication fault between battery and inverter, for more detail setting with different inverter/charger, please contact your supplier for consultation.

3.3.3.3 RUN/ALM/SOC

Mode	Status	RUN	ALM	LED indicator				Description
		●	●	●	●	●	●	
Power off	-	OFF	OFF	OFF	OFF	OFF	OFF	All OFF

Standby	Normal	FLASH1	OFF	According to battery SOC				See note
	Warning	FLASH1	FLASH3					
Charge	Normal	ON	OFF	According to battery SOC (highest SOC LED: FLASH2)				See note
	Warning	ON	FLASH3					
	COCP	FLASH1	OFF	According to battery SOC				Stop charging
Discharge	Normal	FLASH3	OFF	According to battery SOC				See note
	Warning	FLASH3	FLASH3					
	CUVP/PUVP	OFF	FLASH3	OFF	OFF	OFF	OFF	Stop discharging
	DOCP	OFF	ON	OFF	OFF	OFF	OFF	Stop discharging
Temperature	CHTP/DHTP CLTP/DLTP	OFF	ON	OFF	OFF	OFF	OFF	Stop charging/discharging
Failure	Cell/NTC failure Sensor failure MOS failure Reversed polarity /SCP	OFF	ON	OFF	OFF	OFF	OFF	Stop charging/discharging

Note: 'Warning' including items of cell imbalanced/low voltage/high current/high&low temperature.

FLASH Type	ON	OFF
FLASH1	0.25S	3.75S
FLASH2	0.5S	0.5S
FLASH3	0.5S	1.5S

3.4 Protection function

Items	Description	Remark
Charge end COVP POVP	The BMS will stop charging if any cell or PACK voltage reach the protection value and it will be auto-released only when both Pack and cell voltage back to the release voltage range or there	

	is efficient discharge current.	
Discharge end CUVP PUVP	The BMS will stop discharging if any cell or PACK voltage is under the protection value and it will be released only when all the cell voltage back to the release voltage range or there is efficient charge current.	Can Automatic recovery. Please charge timely, otherwise it may be in Low-power mode to be over-discharged and damage battery.
CHTP DHTP	The BMS will stop charging or discharging or both if any cell/environment/MOS temperature is beyond the range.	Automatic recovery when temperature falls.
CLTP DLTP	The BMS will stop charging or discharging or both if any cell/environment/MOS temperature is under the range.	Automatic recovery when temperature rise.
COCP	The BMS will stop charging when the charging current is higher than the protection value. And it will release from the protection when the system delays time is met.	Automatic recovery. If locked after three consecutive times, manual intervention is required.
DOCP	The BMS will stop discharging when the discharging current is higher than the protection value. And it will release from the protection when the system delays time is met	Automatic recovery. If locked after three consecutive times, manual intervention is required.
SCP Reversed polarity	The BMS will stop charging when detect short circuit or reversed polarity.	Charge to release. Manual press reset.
Temperature, Voltage, Current sensor failure	Enter the failure mode, manual intervention is required no charging and discharging.	Manual intervention.
Sleep mode	After reaching a certain condition, BMS will enter dormancy mode to reduce BMS consumption	Charge, press reset or restart to activate.

CAUTION

Please re-charge the battery via MPPT, grid/generator or other energy source within 24h if the battery is over discharged, otherwise, it may be damaged.

NOTICE

Manually short-circuit and reverse the battery will void the warranty.

4 Installation

4.1 Preparation

4.1.1 Safety Compliance

The system installation must be finished by qualified person(s), During the whole installation process, please strictly follow the local safety regulations and related operating procedures.





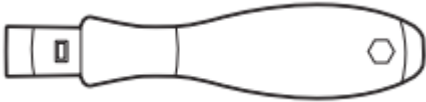

4.1.2 Environment

The operating environment shall meet the following requirements:

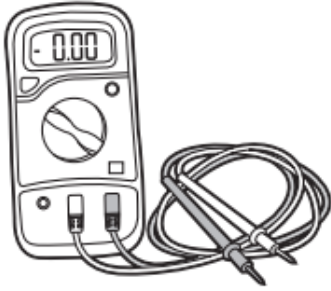
Category	Description
Working temperature	14 °F to 122 °F (-10°C-50°C) (maximum operating range) 59 °F to 86 °F (15°C-30°C)(optimal temperature)
Relative humidity	5%~90%, No condensation
Altitude	<118110 inch 3000m
Safety requirement	<ul style="list-style-type: none"> Do not expose the battery to direct sunlight, rain and snow. Do not place the battery within children/pet touchable area. Do not place the battery near heat source and flammable material Do not drop, deform, impact, cut or spearing with a sharp object. Do not put heavy things on battery. Do not disassemble the battery without Manufacturer's permission. No conductive dust and water or other liquid to contact battery. Follow the emergency measure if there is water invasion or electrolyte and gas leakage. Contact your supplier within 24 hours if any product failure happens.

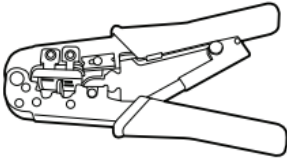
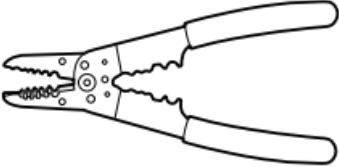
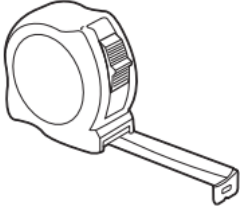
4.1.3 Tools

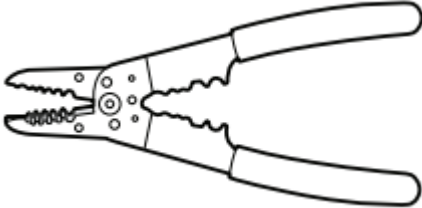
Tools	
Torque screwdriver 	Multi-meter

	
<p>Torque wrench</p> 	<p>Cable crimper</p> 
<p>Wire stripper</p> 	<p>Tape measure</p> 
<p>Flat-head screwdriver</p> 	<p>Phillips-head screwdriver</p> 
<p>Wire stripper</p> 	<p>Drill</p> 
<p>Phillips-screwdriver bit</p> 	

4.2 Inspection

4.2.1 Unpacking

- Please load and unload it in accordance with the specified requirements to prevent sun and rain when you receive the equipment.
- Please check and confirm the goods (such as quantity, appearance, etc.) according to the "scope of delivery " before unpacking.
- Do light take and put during unpacking process to protect the surface coating of the object;
- Please record and feedback to the manufacturer if the inner packing is damaged after unpacking.

4.2.2 Scope of delivery

Check the scope of delivery for completeness and any externally visible damage. Contact your supplier for supplementary delivery if the listed material is incomplete or damaged.

General materials

(Battery unit)

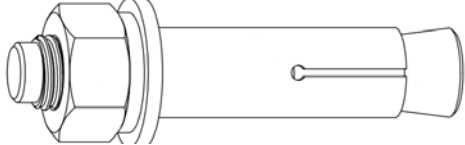

Battery Pack *1pcs		Manual *1pcs	
Type	Detail	Qty.	
Power cable		2pcs	
		2pcs	
Grounding cable		1pcs	
Battery to battery communication cable		1PCS	
Wall mounted bracket		1PCS	
Battery Wall mounted bracket		2PCS	
Wall mounted limit bracket		2PCS	
Floor to wall fixed bracket		2PCS	
Expansion screw	<p>M6*50</p>	2PCS	

Expansion screw	 <p>M8*60</p>	4PCS
-----------------	--	------

For inverter communication PIN definition detail, please check **Appendix I**

NOTICE

Keep the unused cable pins NULL to avoid affecting the closed loop communication.

NOTICE

A ground connection of communication cable may be required from some inverters, please follow the rules from inverter manufacture.

4.3 Start Installation

Qualified person

4.3.1 Remainder

Please check again the following conditions or equipment whether meet the requirements before installation:

- Check if there's enough space for installation, and if the load-bearing capacity of the bracket or cabinet

meets the weight requirements.

- Check whether the power cable pair(s) used meets the maximum current requirement for operation.
- Check whether the overall layout of power supply equipment and batteries at the construction site is reasonable.
- Check whether the installer is wearing anti-static wristband.
- Check whether there're two people on the construction site for installation work.
- Check if there's potential risks at location of installation site, e.g flooding, sun exposure, corrosion, and salt spray.

4.3.2 Procedures

⚠ CAUTION
Injuries may result if the product is lifted incorrectly or dropped while being transported or mounted. Wear suitable personal protective equipment for all work on the product.

⚠ CAUTION
Ensure that no lines are laid in the wall which could be damaged when drilling holes.

4.3.2.1 Floor mounted installation

<p>i. Take the battery pack out from package.</p>	
<p>ii. Fasten the two wall mount brackets together</p>	

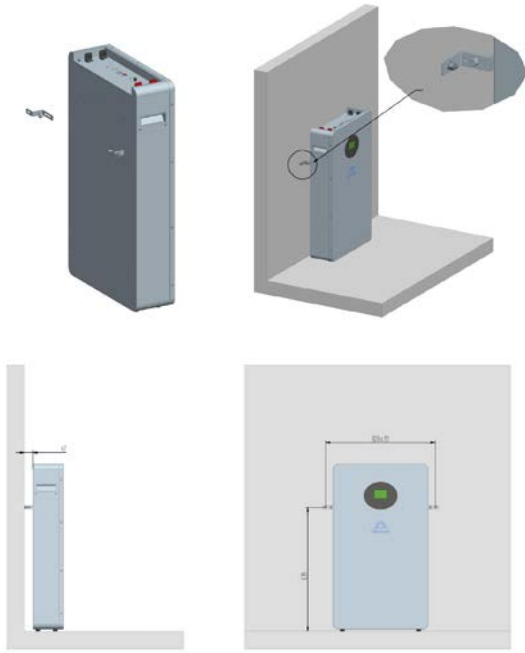
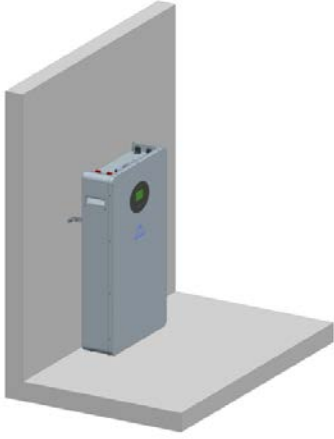
<p>iii. Fix the assembled bracket in the corresponding position of the battery as shown in the figure</p> <p>iv. Attach the battery with the assembled stand to the wall</p>	
<p>v. The installation is completed and the final minor changes are shown on the right</p>	
<p>vi. Finish the cable connection</p>	

4.3.2.2 Wall mounted installation

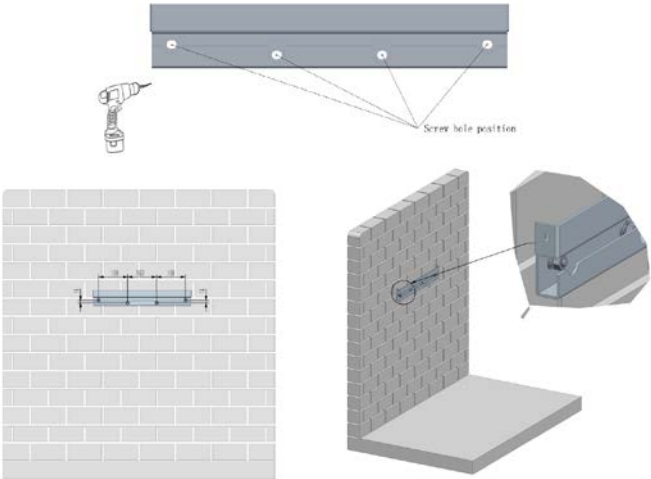
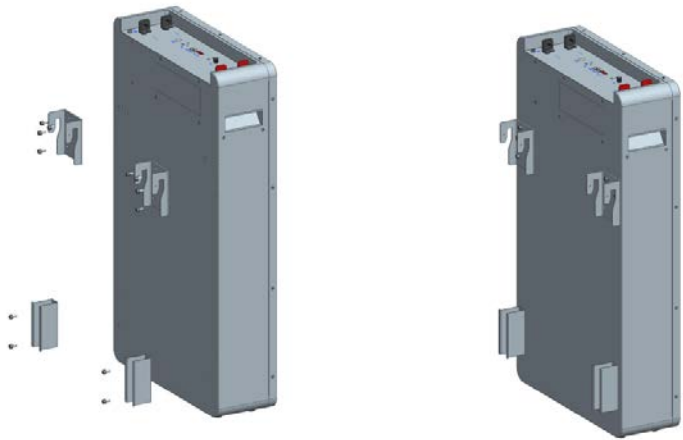
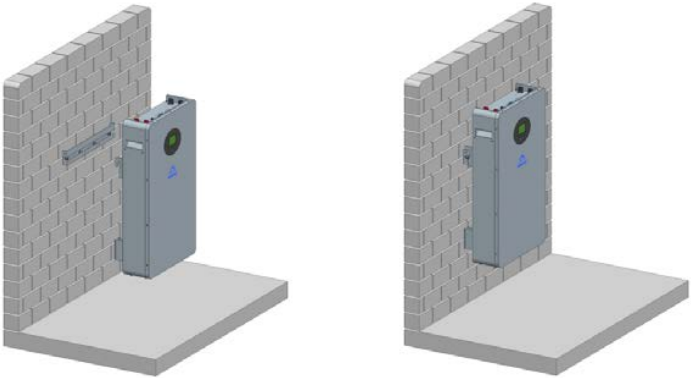
<p>i. Take the battery pack out from carton.</p>	
<p>ii. Take out the wall mounting bracket, place it onto the wall horizontally and mark the hole position on the panel.</p> <p>iii. Drill holes in the wall for the M10 expansion bolt. The drilling depth should be at least 60 mm, insert the bolt.</p>	
<p>iv. Fix the bracket with the nut</p> <p>v. Use combination screws to secure wall mount components to the battery</p>	
<p>vi. Hang the battery on the wall bracket</p>	
<p>vii. Finish the cable connection</p>	

⚠ CAUTION

Please fix the parallel cable between batteries with the wall or other part to avoid enduring the gravity of conductor for long time, resulting in an increase in the internal resistance of the connection.

4.3.3 Tips

4.3.3.1 Installation not allowed

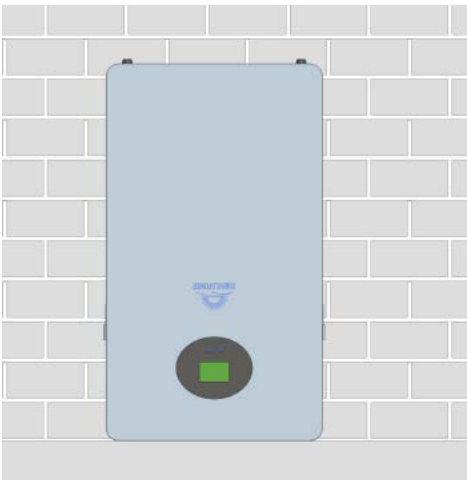
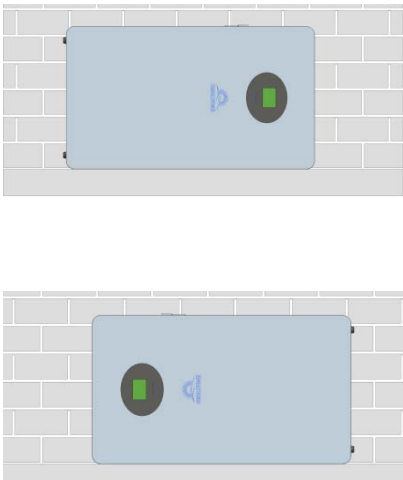
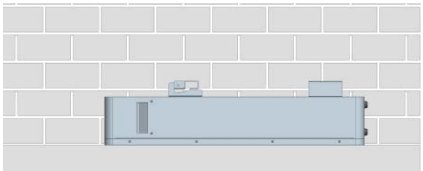
irect upside down	eft/Right side flip	loor side flip
 <p style="text-align: center; color: red; font-weight: bold;">X</p>	 <p style="text-align: center; color: red; font-weight: bold;">X</p>	 <p style="text-align: center; color: red; font-weight: bold;">X</p>
irect upside down	ide flip	ront side down

5. Cable connection and commissioning

5.1 Get battery ready

5.1.1 Ensure all the battery is in OFF mode, check and confirm the installation is tighten and stable.

5.1.2 Check the number and specification of cable kit accessories are correct according to the Scope of delivery item, if you are making cable yourself, please follow manufacturer's requirements.

5.1.3 Switch on all battery individually before wiring, check whether there is any alarm/protection information, if yes, turns to troubleshooting. Then switch off all batteries.

5.2 Grounding cable connection

5.2.1 Take out the grounding screw on the battery panel, and get the cable conductor through it.

5.2.2 Fix them together, with a cylinder screwdriver and tighten it.

5.2.3 Connect the grounding cable with next battery module.

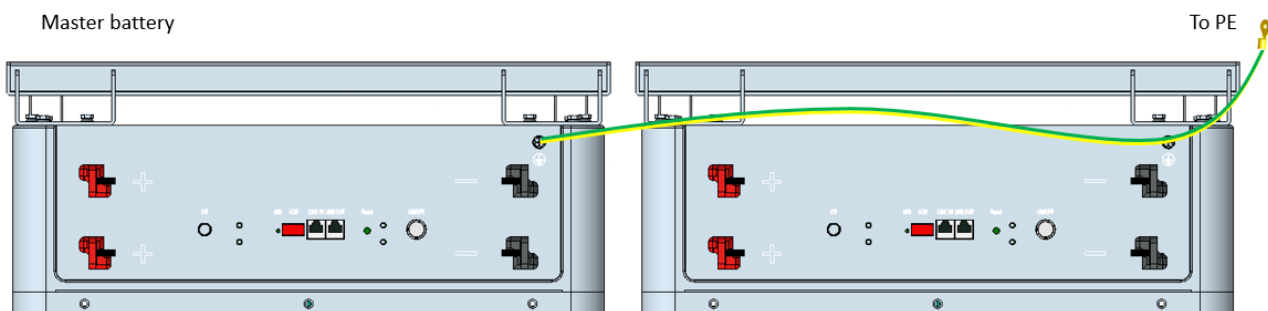

5.3 Communication cable connection

5.3.1 Take out battery to battery communication cable.

5.3.2 Confirm the location of Master battery, insert the RJ45 plug into the Link Out port and connect the other side to next battery Link IN port, daisy chained all batteries.

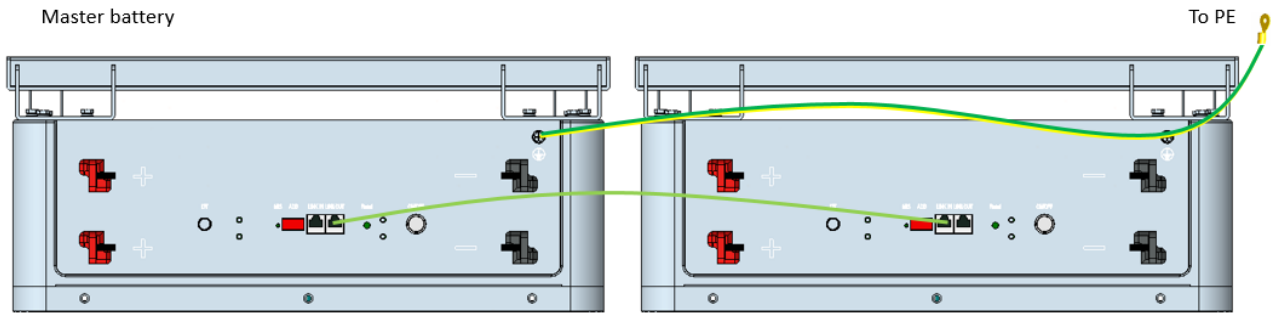

Note: the module with empty Link IN port is Master battery

⚠ NOTICE

The BMS inside the battery pack will automatically terminate BOTH end of CANBUS pins, DO NOT need to plug the 120 Ω terminator again.

5.4 DC power cable connection

5.4.1 Take out battery to battery power parallel cable.

5.4.2 Lock the terminals on the battery terminals and secure tightly with nuts.

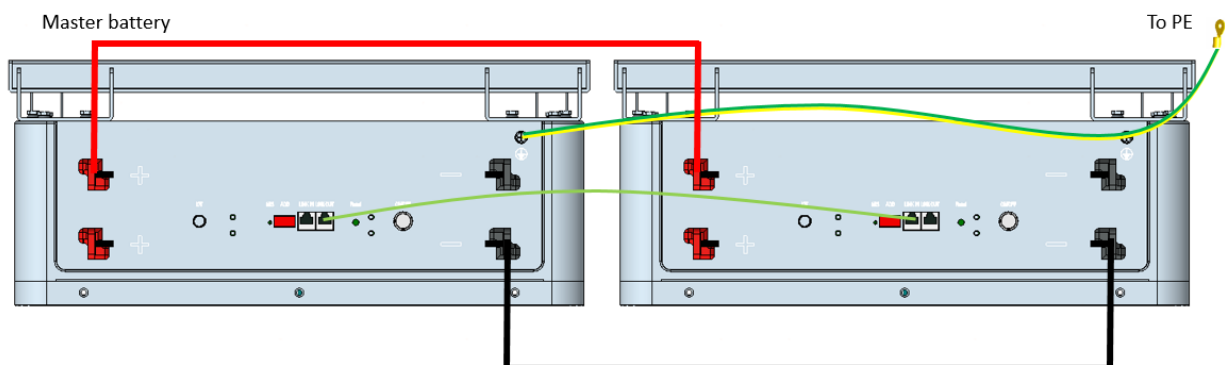

5.5 Connecting with inverter

⚠ CAUTION

Confirm inverter AC input and PV input is disconnected before wiring connection, and the DC/ signal switch of inverter/charger is in off status.

5.5.1 Connecting Master battery Link IN port with inverter CAN or RS485 communication port via inverter communication cable (*Version I/II/III or customized*).

5.5.2 Connecting battery OUTPUT (+) with inverter battery INPUT (+), battery OUTPUT (-) with inverter battery INPUT (-), an external disconnection breaker between battery system and inverter is recommended, choose the corresponding power cable pair and wiring them correctly.

Note:

NOTICE

Choose the suitable disconnection breaker considering the inverter power/current, rated voltage, tripping characteristic etc.

Wiring diagram allowed:

i. Single pair cable wiring----200A, 10KW rating

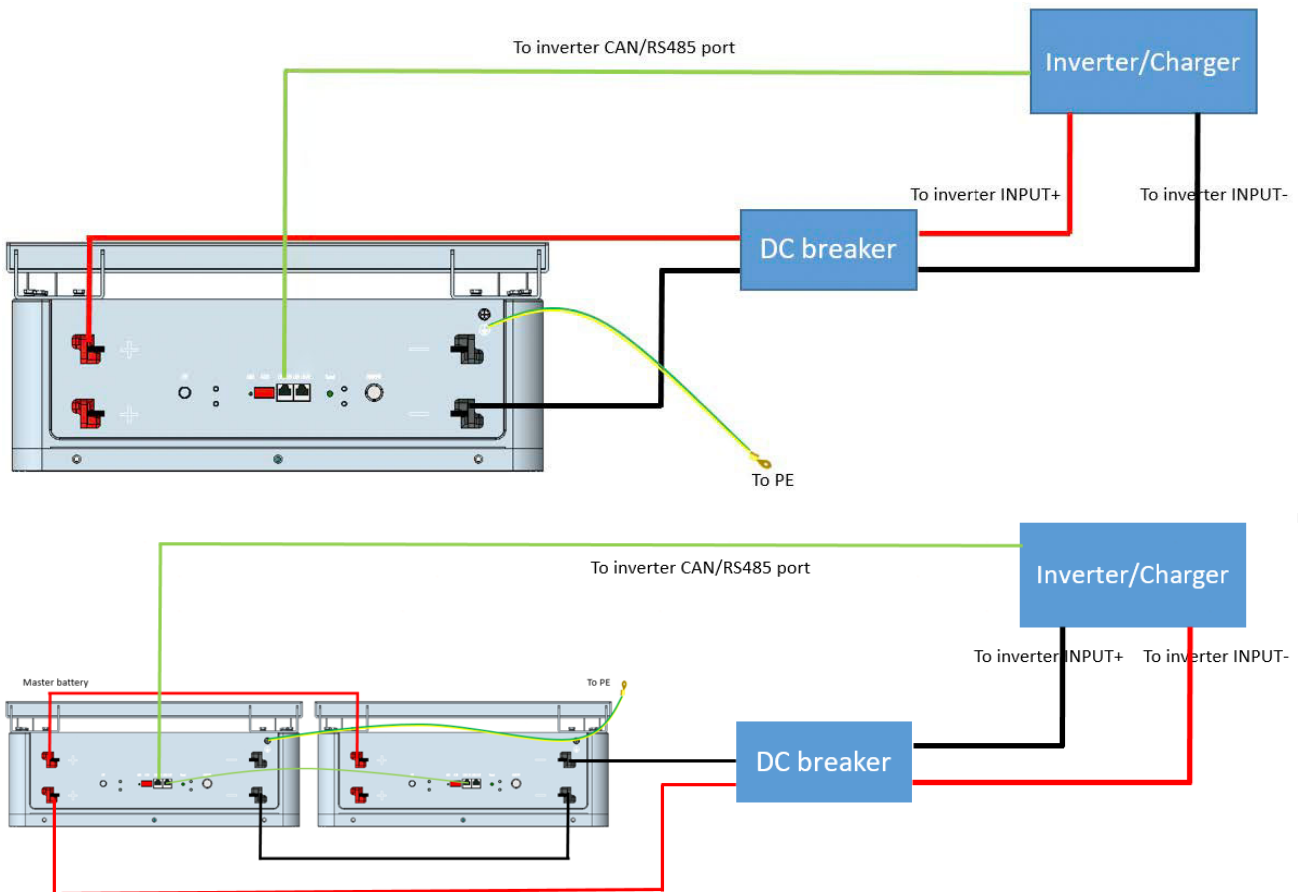

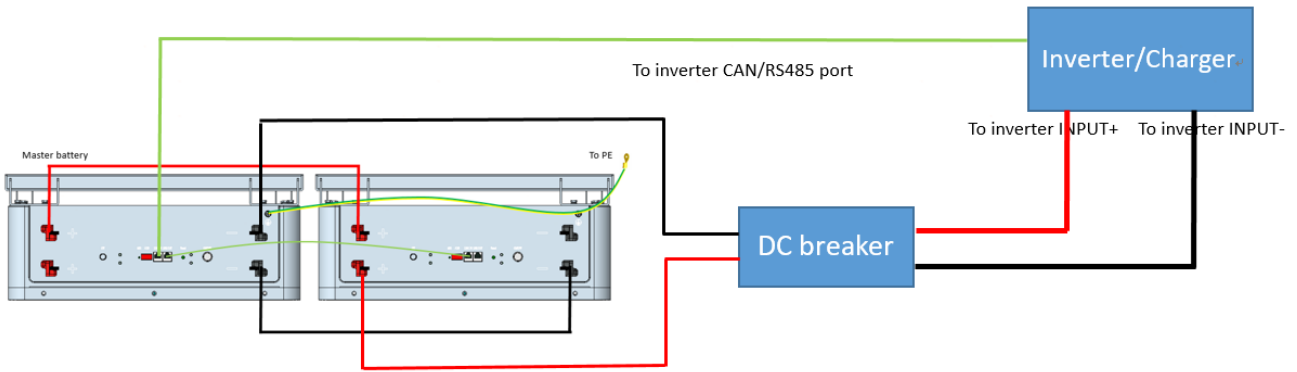

ii. Double pairs cable wiring---300A, 10KW rating

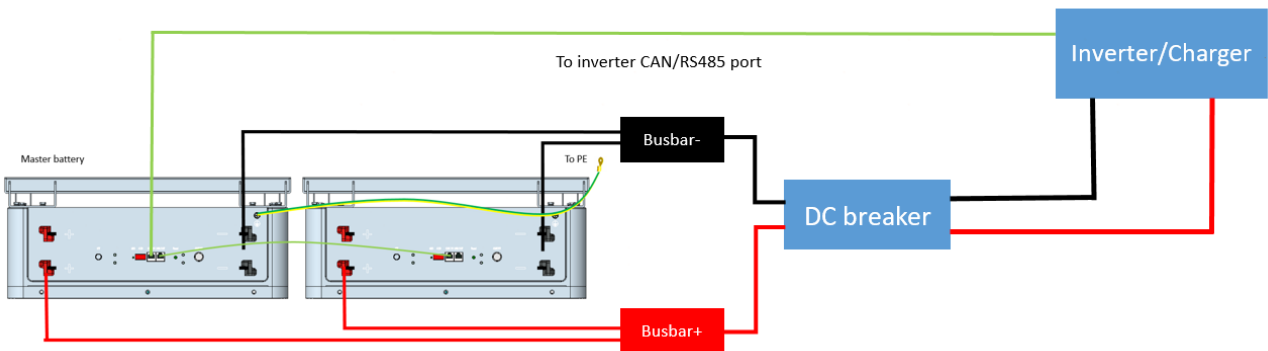

iii. Multiple towers and inverters cable wiring

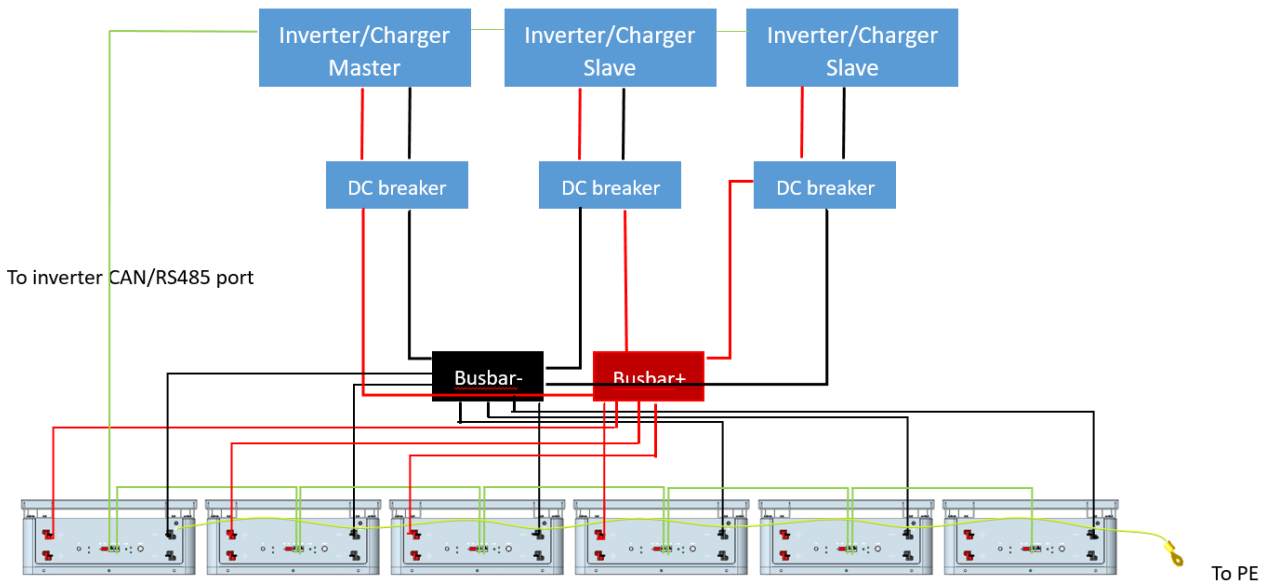

Considering system stability, when you install multiple batteries, please always keep a certain capacity margin of 30~50%. it is recommended to configure the inverter capacity with battery energy in 1: 2

proportion, for instance, if you have a 10KW rated inverter, connect 2 pieces(20KWh) or more batteries.

Wiring diagram not allowed:

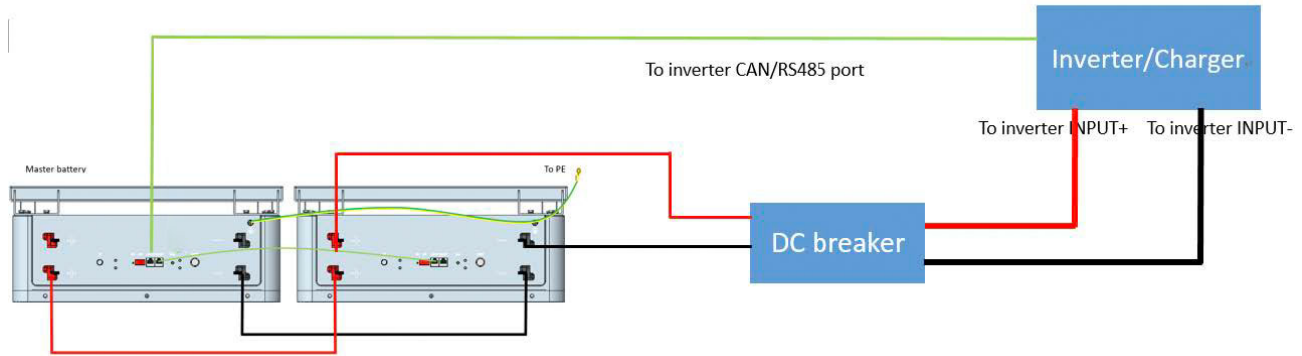

⚠ NOTICE

The maximum communication cable length is required to be less than 15m between inverter/charge and battery.

The maximum power cable length is suggested to be less than 10m between inverter/charge and battery.

⚠ CAUTION

The maximum allowable current per power cord is 125A, with 100A recommended for continuous use, and the maximum allowable current for the battery terminals is 200A, with 150A recommended for continuous use. Please use the appropriate number of power cord pairs according to the site configuration and local connection requirements, standards and directives.

5.6 Commissioning

5.6.1 Set the DIP address of the Master battery (and the Slave battery if there is any RS485 baud rate changed).

5.6.2 Switch on all battery modules, wait for 10s, make sure that only M/S led is on Master battery.

5.6.3 Turn on the breaker between the inverter and battery if there is any, then turn on the inverter/charger isolator.

5.6.4 Finish the setting on inverter/charger or any other control devices, if everything is correct, you are ready to use the system.

No.	Inverter setting parameters	Detail
1	Absorption voltage	56.0V
2	Float voltage	54.6V
3	Re-charge/Generator start voltage	$\geq 50V$
4	Re-start voltage	52V
3	Low SOC limit (Grid-tied)	10/20% (differ from inverter brand)
5	Low SOC cut-off (Off-grid)	4%
6	Low Voltage cut-off	48.0V
7	Rated charging current limited value	100A*N (N is the Quantity of the battery pack)
8	Rated discharging current limited value	100A*N (N is the Quantity of the battery pack)
9	Max. charging current limited value	200A*N (N is the Quantity of the battery pack)
10	Max. discharging current limited value	200A*N (N is the Quantity of the battery pack)
11	Force charge/ Activate	Enable

For more information to connect with different inverter/charger, please contact your supplier for technical support.

CAUTION

If your system is a back-up or off-grid system, make sure your configuration can cover the worst situation to avoid battery to be over-discharged.

5.7 Switch off battery

5.7.1 Turn off the inverter.

5.7.2 Turn off the disconnection breaker if there is any.

5.7.3 Turn off all batteries signal switch.

6 Troubleshooting and FAQ

Items	Solution	Measure
Unable to start	<ol style="list-style-type: none"> 1. Power on battery and press RESET 6s to observe whether the battery can be started. 2. Charge the battery use a charger or inverter to provide 54~57.6V voltage and observe it can be started. 	<p>If the abnormal status still alive after above steps, please contact your supplier.</p> <p>If there is any other situation(s) excluding in this table, turn off the fault battery, contact your supplier.</p>
Unable to charge	<ol style="list-style-type: none"> 1. Check whether the cable connection between the battery and the inverter/charger is correct. 2. Check whether the inverter/charger setting is correct. 3. Check whether the battery is in charge protection mode, if yes, try to discharge the battery. 	
Unable to discharge	<ol style="list-style-type: none"> 1. Check whether the cable connection between the battery and the inverter/charger is correct 2. Check whether the battery occurs short circuit, reverse connection, pre-charge failure during connection inverter etc. 3. Check whether the battery is in discharge protection mode, if yes, try to charge the battery. 	
High/Low temperature	<ol style="list-style-type: none"> 1. Stop the battery system for a while, check whether the installation location temperature meet the requirement. 2. Avoid continuous full charging and discharging. 	
High current	Check the configuration and parameters setting on the inverter/charger is correct.	
ALM always on	<ol style="list-style-type: none"> 1. Check the fault information on the inverter APP or display if possible. 2. Ask your supplier to offer BMS monitoring software to locate the reason and back to them for solution. 	
Communication fail	<ol style="list-style-type: none"> 1. Check the communication cable type is correct and is contacted well. 2. Check the DIP switch setting is correct. 3. Check the inverter protocol related setting is correct. 4. Check both battery and inverter are working properly. 	
LCD Display		
●HV	<ol style="list-style-type: none"> 1. Stop charging the battery. 2. Try to discharge the battery. 	
●LV	<ol style="list-style-type: none"> 1. Stop discharging the battery. 2. Try to charge the battery. 	
●COC	<ol style="list-style-type: none"> 1. Lower the charge current 	
●DOC	<ol style="list-style-type: none"> 1. Lower the discharge current 	
●CHT& ●DHT	<ol style="list-style-type: none"> 1. Stop the battery system for a while, check whether the installation location temperature meet the requirement. 2. Avoid continuous full charging and discharging. 	

●SL	1. Stop discharging the battery. 2. Try to charge the battery.	
●AFE	1. please contact your supplier to replace the BMS.	

Q1: *Battery maximum SOC is 98~99% and never goes to 100%SOC during daily cycle use, why?*

This is normal and have no influence on capacity, usually BMS will calibrate the SOC to 100% when reached cut-off current or trigger HVP, however, to avoid battery from being overcharged and to extend the cycle life as longer as possible, we left a room and set a charging profile to let battery charge slowly near full, please float the battery about 0.5~1 hour to calibrate the SOC.

Q2: *'High voltage' and 'cell unbalance' warning and alarm in rare cases, does it mean battery is damaged?*

No. This is not unusual and happened on new batteries that are not balanced yet, please lower the maximum charge voltage (54.6V) and float the battery via grid or generator. If not solved, please contact your supplier.

Q3: *When having multiple batteries in parallel connection, the battery on the end can't be fully charged.*

Pay attention to your wiring diagram, please always follow the manual wiring advises and choose proper cable size and pair.

Q4: *The current is 0A when connecting with a very small load at the situation that having multiple batteries in parallel connection, how to solve it?*

Each BMS has a threshold current of 0.5A (~25W) before it begins to report, this leads the inaccurate display of the current.

Q5: *SOC is not accurate or suddenly jumps to 100% during charging.*

This mostly happen in off-grid applications on batteries that have not been calibrated SOC for a long time or situations that are similar to Q4 that with inverter in Idle mode or a small DC load or store the battery for a long time, we suggest fully charging at once the batteries per month refer to Q1.

Q6: The system is still running when the inverter log shows 'internal failure' Warning.

This is our logic and this warning flag indicates there is 1 or more module(s) is in communication offline from the system, the system will derating and until communication is recovered.

Q7: Inverter pulling power from Grid to charge batteries in self-consumption mode.

When reached certain conditions such as low state of charge etc., battery will send charge request to ask inverter to charge the batteries, to avoid this, please discharge DOD as manual suggested.

7. Transport, Storage

- Do not violently shake, impact or squeeze, and prevent sun and rain during the transportation.
- Do light take and put and strictly prevent falling, rolling, and heavy pressure during loading and unloading.
- The battery should be placed in a dry, clean, dark, and well-ventilated indoor environment for long-term storage, and the recommended storage temperature range is 15~30°C.
- No harmful gases, flammable and explosive products and corrosive chemical substances in the storage location.
- The batteries should be stored and transported in close to 50% SOC, do not store over 80%SOC for long time.
- If do not use for a long time, the battery needs to be charged every 6 months.
- No fall down, no pile up over 6 layers, and keep face up.

8. Disposal of battery

Disposal of battery must comply with the local applicable disposal regulations for electronic waste and used batteries, please review your local Battery recycling or management regulations or contact your supplier for more information.

Appendix I

Connect with SUNGOLDPOWER SPH/SG inverter/charger

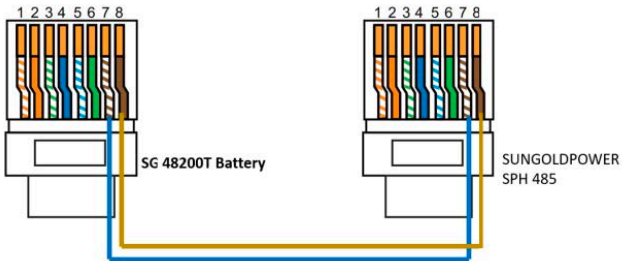

Battery RS485 port	SUNGOLDPOWER SPH 485	Cable suggest
Pin7	Pin7	Version-II(485)
Pin8	Pin8	

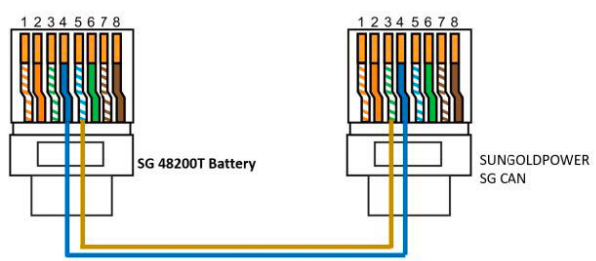

Battery CAN port	SUNGOLDPOWER SG CAN	Cable suggest
Pin4	Pin4	Version-II(CAN)
Pin5	Pin5	

Connect with Victron GX & inverter/charger

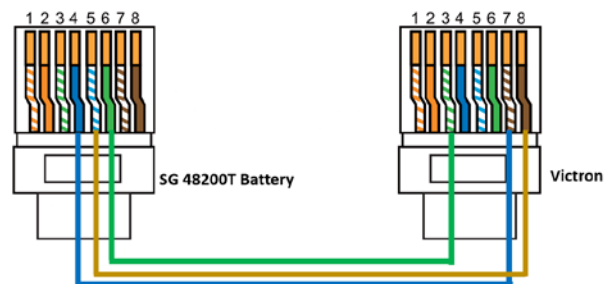

Battery CAN port	Victron VE.CAN/BMS CAN	Cable suggest
Pin4	Pin7	Version-I(CAN)
Pin5	Pin8	
Pin6	Pin3	

Connect with SMA inverter/charger

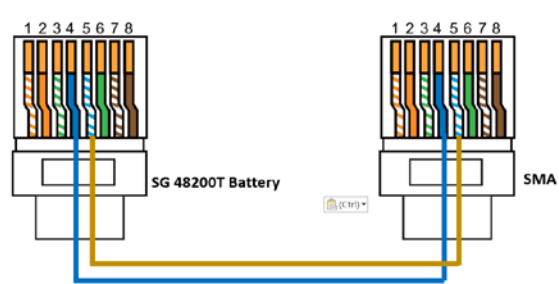

Battery 485 port	SMA sunny island	Cable suggest
Pin4	Pin4	Version-II(CAN)
Pin5	Pin5	
Pin6 (optional)	Pin2 (optional)	

Connect with Schneider inverter/charger

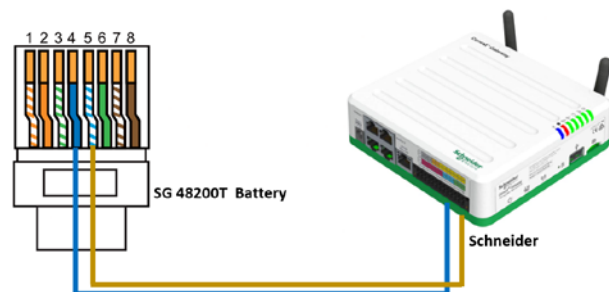

Battery CAN port	Conext Gateway	Cable suggest
Pin4	Pin14	customized
Pin5	Pin12	
Pin6 (optional)	Pin10 (optional)	

Connect with Studer inverter/charger

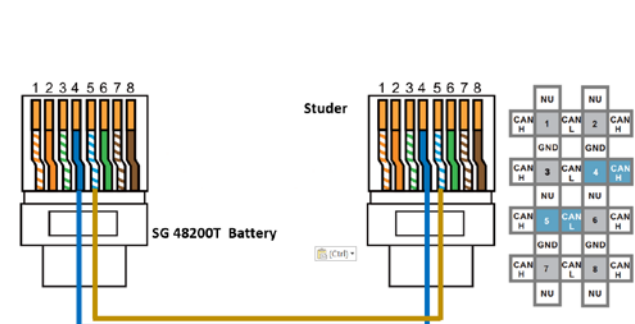

Battery CAN port	X-Com CAN	Cable suggest
Pin4	Pin4	Version-II(CAN)
Pin5	Pin5	

Connect with GOODWE hybrid inverter

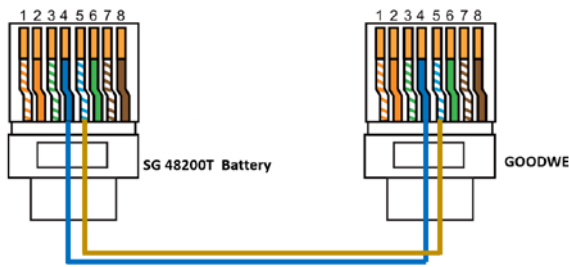

Battery CAN port	GOODWE BMS CAN	Cable suggest
Pin4	Pin4	Version-II(CAN)
Pin5	Pin5	

Connect with Sol-Ark hybrid inverter

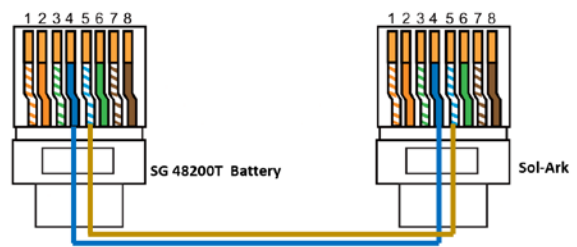

Battery CAN port	Sol-Ark CAN	Cable suggest
Pin4	Pin4	Version-II(CAN)
Pin5	Pin5	
Pin6 (optional)	Pin6 -outdoor Pin2 -indoor (optional)	

Connect with Growatt inverter

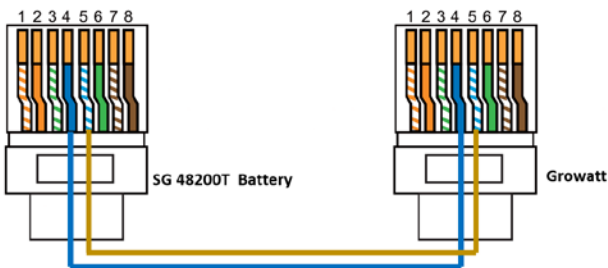

Battery CAN port	Growatt BMS communication port	Cable suggest
Pin4	Pin4	Version-II(CAN)
Pin5	Pin5	

Connect with Solis inverter

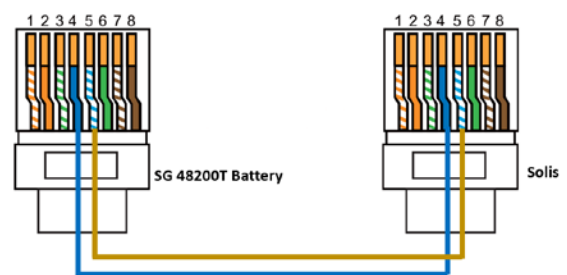

Battery 485 port	SMA sunny island	Cable suggest
Pin4	Pin4	Version-II(CAN)
Pin5	Pin5	

Connect with Deye hybrid inverter

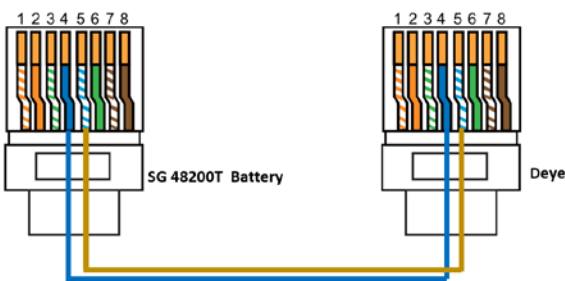

Battery CAN port	Deye CAN	Cable suggest
Pin4	Pin4	Version-II(CAN)
Pin5	Pin5	

Connect with SUNSYNK hybrid inverter

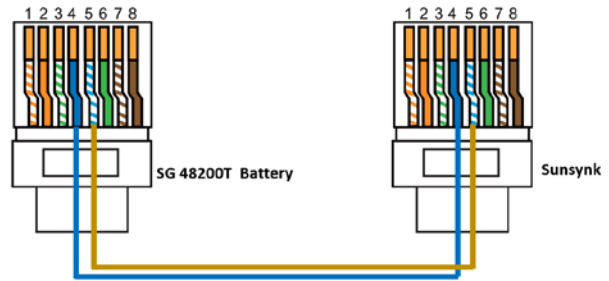

Battery CAN port	Sunsynk CAN	Cable suggest
Pin4	Pin4	Version-II(CAN)
Pin5	Pin5	

Connect with SAJ hybrid inverter

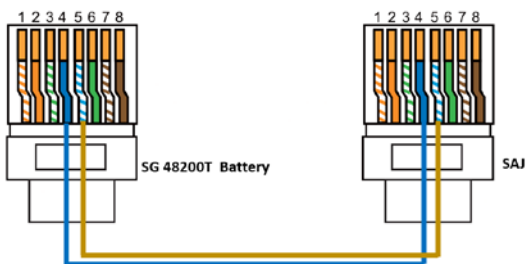

Battery CAN port	SAJ CAN	Cable suggest
Pin4	Pin4	Version-II(CAN)
Pin5	Pin5	

Connect with LUXPOWER inverter

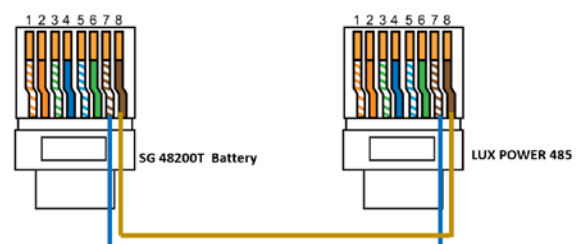

Battery RS485 port	LUX 485	Cable suggest
Pin7	Pin7	Version-II(485)
Pin8	Pin8	

Connect with Megarevo/INVT inverter

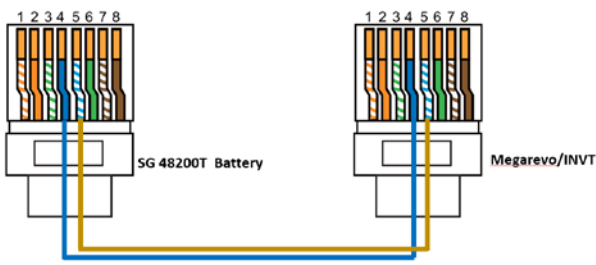

Battery CAN port	Megarevo CAN	Cable suggest
Pin4	Pin4	Version-II(CAN)
Pin5	Pin5	

Connect with MUST inverter

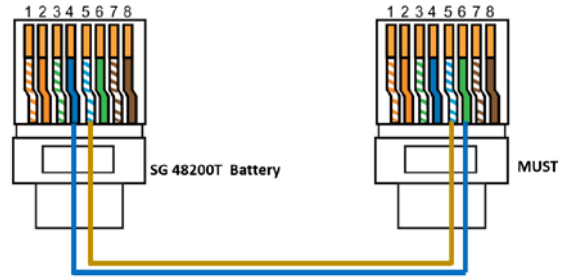

Battery CAN port	MUST CAN	Cable suggest
Pin4	Pin6	customized
Pin5	Pin5	

Connect with Alpha & Outback energy inverter

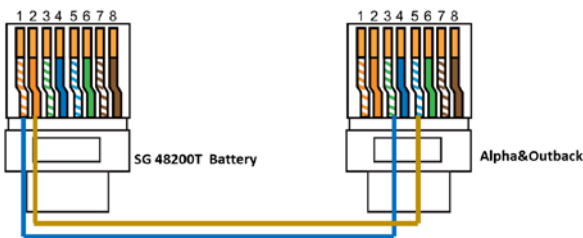

Battery RS485 port	Alpha&Outback BMS communication	Cable suggest
Pin1	Pin3	Version-III(RS485)
Pin2	Pin5	

Connect with Voltronic inverter

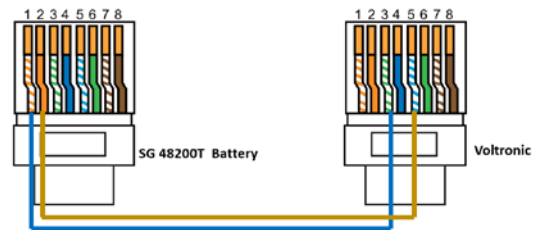

Battery RS485 port	Voltronic BMS communication	Cable suggest
Pin1	Pin3	Version-III(RS485)
Pin2	Pin5	

Connect with Phocos inverter

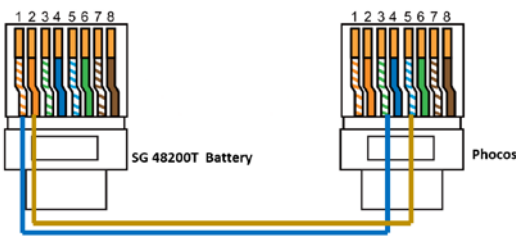

Battery RS485 port	Phocos BMS communication	Cable suggest
Pin1	Pin3	Version-III(RS485)
Pin2	Pin5	

Connect with Mpp solar inverter

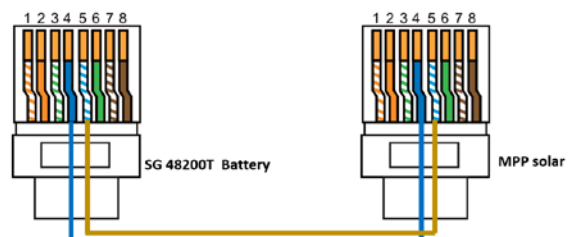

Battery CAN port	MPP BMS communication	Cable suggest
Pin1	Pin3	Type III
Pin2	Pin5	